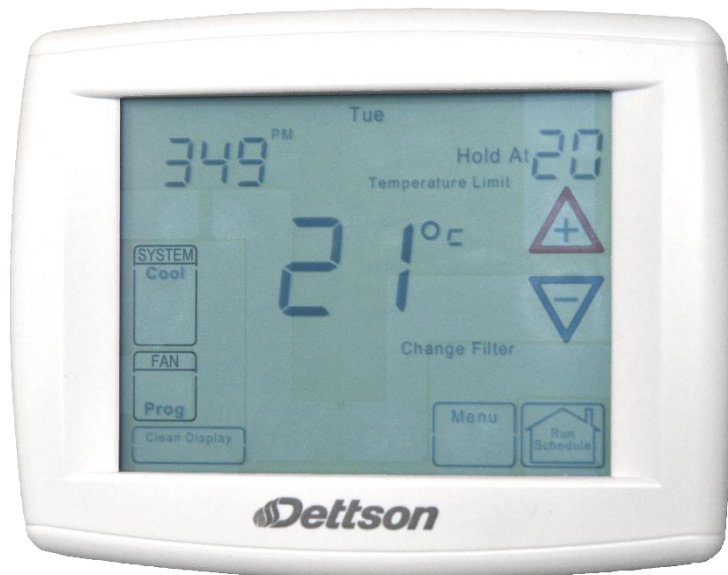




# INSTALLATION AND OPERATING INSTRUCTIONS

## Modulating Touchscreen Thermostat

**Model R02P030**



**Save these instructions for future use!**

FAILURE TO READ AND FOLLOW ALL INSTRUCTIONS CAREFULLY BEFORE INSTALLING OR OPERATING THIS CONTROL COULD CAUSE PERSONAL INJURY AND/OR PROPERTY DAMAGE.

## TABLE OF CONTENT

1- Applications..... 3	9.5- Cooling/Dehumidifier ..... 15
2- Specifications ..... 3	9.6- Choose the Fan Setting (Auto or On or Prog) ..... 15
3- Safety ..... 3	9.7- Choose the System Setting (Cool, Off, Heat, Em, Auto)..... 15
4- Installation ..... 4	9.8- Manual operation for normal Mode Thermostats..... 15
4.1- Remove old thermostat ..... 4	9.9- Manual Operation (Bypassing the Program) Programmable Thermostats ..... 16
4.2- Installing new thermostat..... 4	9.10- Program Override (temporary override). 16
4.3- Battery Location..... 4	9.11- Special Test Mode for PWM (V) output (Installer function only) ..... 16
5- Wiring Connections ..... 5	9.12- Set Current Time and Day ..... 16
6- Wiring diagrams ..... 5	10- Programming ..... 16
6.1- Single stage, multi-stage, heat pump ..... 5	10.1- Automatic Daylight Saving Calculation .. 16
6.2- Single stage, Multi-stage, AC ..... 6	10.2- Programmable Fan Option ..... 17
7- Thermostat quick reference..... 7	10.3- Wire Remote Temperature sensing ..... 17
7.1- Home screen Description ..... 7	10.4- Weight of Remote Reading..... 17
7.2- Programming and Configuration Items .... 8	10.5- Call for Service indicator..... 18
8- Installer/Configuration menu ..... 9	10.6- Dual Fuel Temperature Setpoint..... 18
9- Operating your thermostat..... 14	11- Troubleshooting ..... 19
9.1- Check thermostat operation ..... 14	
9.2- Fan operation ..... 14	
9.3- Heating/humidifier..... 14	
9.4- Emergency Mode ..... 14	

## LIST OF FIGURES

Figure 1: Thermostat Base..... 4	Figure 5: Two Stage..... 6
Figure 2: Typical Dual Fuel Application - Single Stage Heat Pump ..... 5	Figure 6: Typical Wiring for 120V Humidifier System 7
Figure 3: Two Stage..... 6	Figure 7: Typical Wiring for 24V Humidifier System ..7
Figure 4: Typical Single Stage AC ..... 6	Figure 8: Home Screen Display ..... 7
	Figure 9: Programming & Configuration Items ..... 8

## LIST OF TABLES

Table 1: Thermostat application guide ..... 3	Table 4: Configuration Menu ..... 9
Table 2: Table of specifications..... 3	Table 5: Dual Fuel Settings..... 18
Table 3: Terminal designation descriptions..... 5	

# 1-APPLICATIONS

**Table 1: Thermostat application guide**

Description	
Modulating PWM output, gas furnace	Yes
Heat Pump (with Aux. or Emergency Heat), 2 Stage	Yes
Systems with up to 3 Stages Heat, 2 Stages Cool	Yes
Heat Only Systems	Yes
Wired Remote Temperature Sensor (Indoor or Outdoor)	Yes
Dual Fuel Feature (Heat Pump Mode)	Yes
Compressor Fault Detection	Yes
Humidification Control	Yes
Dehumidification Control	Yes

Please refer to the system installation and operating manual for more detailed instructions and options.

# 2-SPECIFICATIONS

**Table 2: Table of specifications**

Electrical Rating:	
Battery Power	mV to 30VAC, NEC Class II, 50/60 HZ or DC
Input-Hardwire	20 to 30VAC
Terminal Load	1.5A per terminal, 2.5A maximum all terminals combined
Setpoint Range	45 to 99°F (7 to 37°C)
Differential (Single Stage)	Heat 0.6°F (0.33°C); Cool 1.2°F (0.67°C)
Differential (Multi-Stage)	Heat 0.6°F (0.33°C); Cool 1.2°F(0.67°C)
Differential (Heat Pump)	Heat 1.2°F (0.67°C); Cool 1.5°F (0.83°C)
Operating Ambient	32°F to +105°F (0 to +41°C)
Operating Humidity	90% non-condensing max.
Shipping Temperature Range	-4 to +150°F (-20 to +65°C)
Dimensions Thermostat	4-9/16"H x 5-13/16"W x 1-3/16"D

# 3-SAFETY



## CAUTION

To prevent electrical shock and/or equipment damage, disconnect electric power to system at main fuse or circuit breaker box until installation is complete.

## ATTENTION: MERCURY NOTICE

This product does not contain mercury. However, this product may replace a product that contains mercury.

Mercury and products containing mercury must not be discarded in household trash. Do not touch any spilled mercury. Wearing non-absorbent gloves, clean up any spilled mercury and place in a sealed container. For proper disposal of a product containing mercury or a sealed container of spilled mercury, place it in a suitable shipping container. Refer to [www.thermostat.recycle.org](http://www.thermostat.recycle.org) or [www.switchthestat.ca](http://www.switchthestat.ca) for location to send product containing mercury

## 4-INSTALLATION

### **WARNING**

Thermostat installation and all components of the control system shall conform to Class II circuits per the NEC/CEC code.

#### 4.1- REMOVE OLD THERMOSTAT

A standard heat/cool thermostat consists of three basic parts:

1. The cover, which may be either a snap-on or hinge type;
2. The base, which is removed by loosening all captive screws;
3. The switching subbase, which is removed by unscrewing the mounting screws that hold it on the wall or adapter plate. Before removing wires from old thermostat, label each wire with the terminal designation from which it was attached. Disconnect the wires from the old thermostat one at a time. Do not let wires fall back into the wall.

#### 4.2- INSTALLING NEW THERMOSTAT

1. Pull the thermostat body off the thermostat base. Forcing or prying on the thermostat will cause damage to the unit.
2. Place base over hole in wall and mark mounting hole locations on wall using base as a template.
3. Move base out of the way. Drill mounting holes. If you are using existing mounting holes and the holes drilled are too large and do not allow you to tighten base snugly, use plastic screw anchors to secure the base.
4. Fasten base snugly to wall using mounting holes shown in Figure 1 and two mounting

screws. Leveling is for appearance only and will not affect thermostat operation.

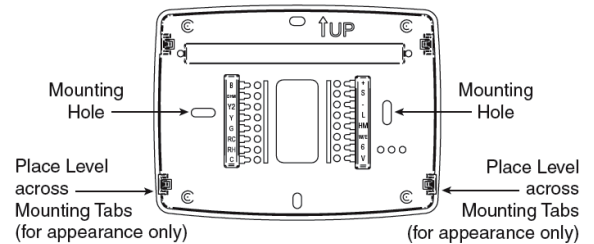
5. Connect wires to terminal block on base using appropriate wiring schematic (see Wiring diagrams section 6).
6. Push excess wire into wall and plug hole with a fire resistant material (such as fiberglass insulation) to prevent drafts from affecting thermostat operation.
7. Carefully line the thermostat up with the base and snap into place.

#### 4.3- BATTERY LOCATION

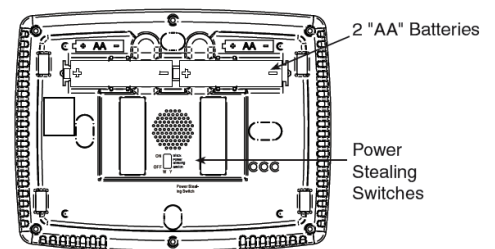
2"AA" alkaline batteries are included in the thermostat at the factory with a battery tag to prevent power drainage. Remove the battery tag to engage the batteries.

To replace batteries, set system to OFF, remove thermostat from wall and install the batteries in the rear along the top of the thermostat (see Figure 1)

Figure 1: Thermostat Base



Rear view of thermostat



# 5-WIRING CONNECTIONS

Refer to equipment manufacturers' instructions for specific system wiring information. After wiring, see CONFIGURATION section for proper thermostat configuration.

For wiring diagrams, see next page. Wiring diagrams shown are for typical systems and describe the thermostat terminal functions.

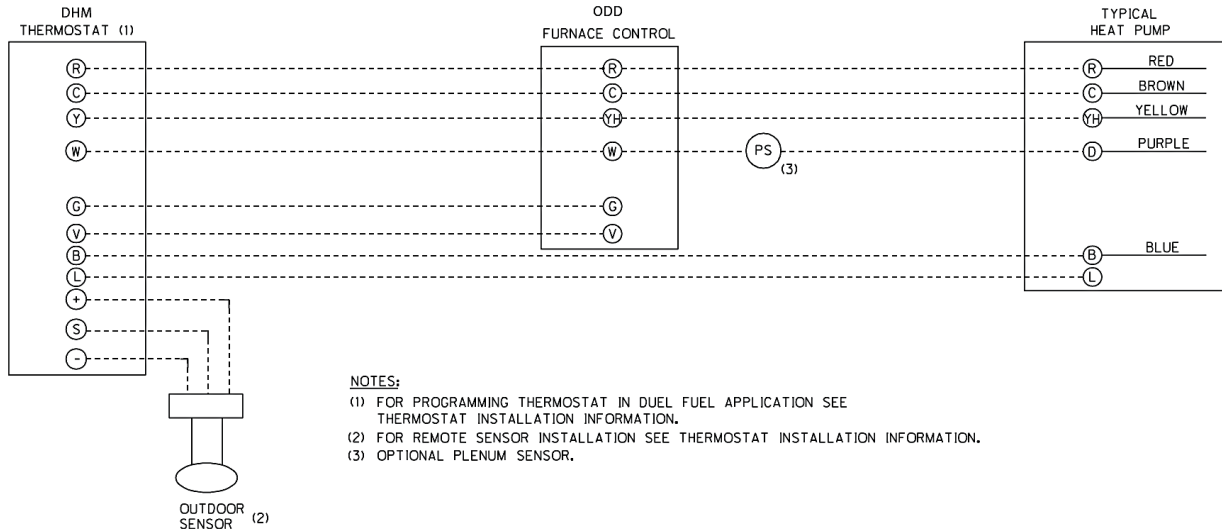
**Table 3: Terminal designation descriptions**

Terminal Designation	Description
B	Changeover valve for heat pump energized constantly in heating mode (default ON)
DHM	De-humidification Relay
Y2	2nd Stage Compressor
Y	Compressor Relay
G	Fan Relay
RC	Power for Cooling
RH	Power for Heating
C	Common wire from secondary side of cooling
V/W2	PWM Output
6	Powered closed 3rd wire for 3-wire Zone
W/E	Heat Relay/Emergency Heat Relay (Stage 1)
HM	Humidification Relay
L	Compressor malfunction or Comfort Alert signal input
-	Common (DC) for wired remote temperature sensor
S	Frequency signal from remote temperature sensor
+	Power (DC) to remote temperature sensor

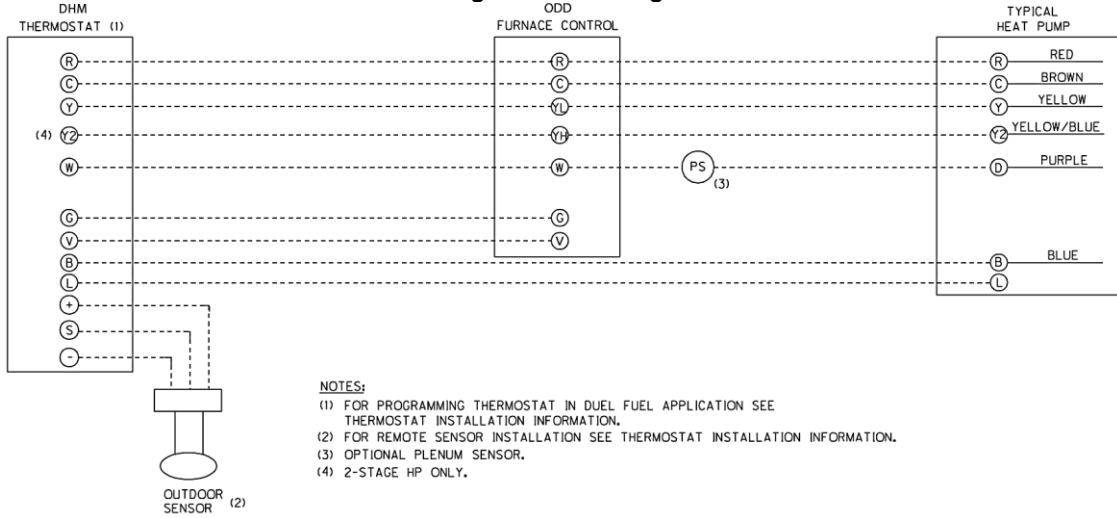
# 6-WIRING DIAGRAMS

## 6.1- SINGLE STAGE, MULTI-STAGE, HEAT PUMP

**Figure 2: Typical Dual Fuel Application - Single Stage Heat Pump**

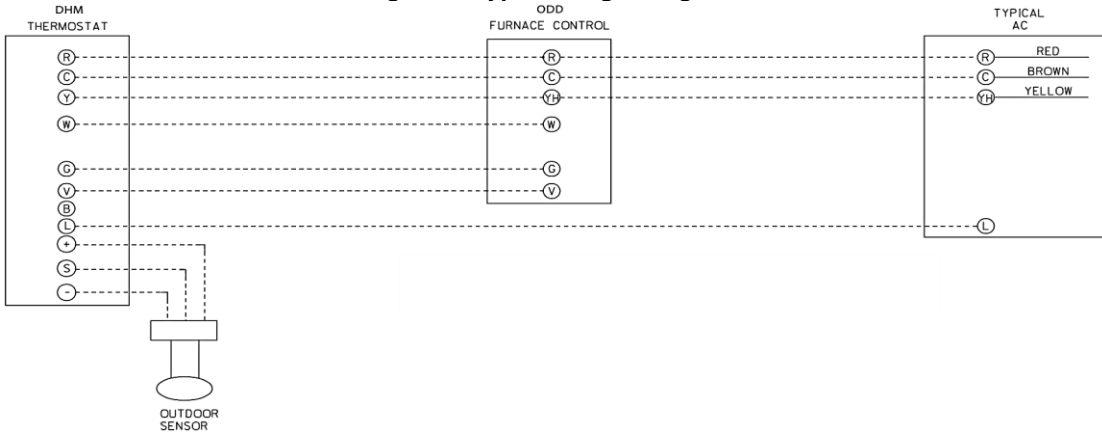


**Figure 3: Two Stage**

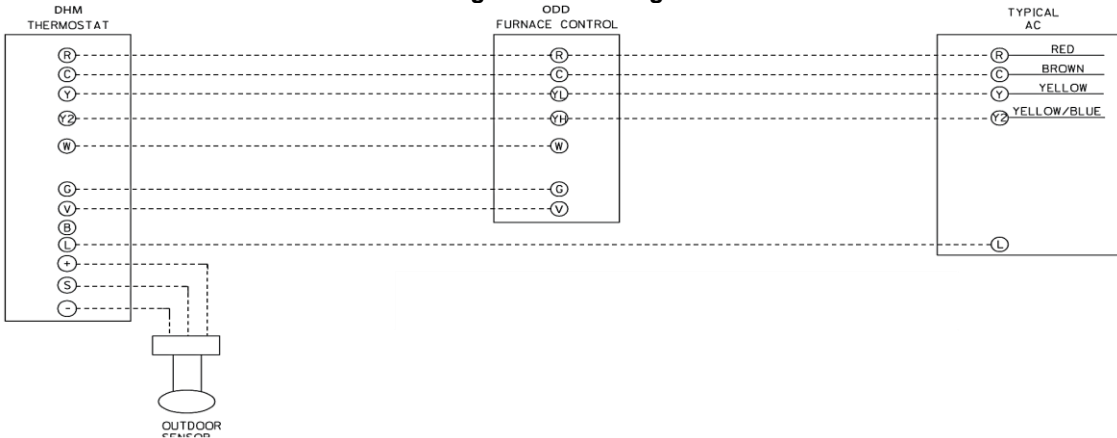


**6.2- SINGLE STAGE, MULTI-STAGE, AC**

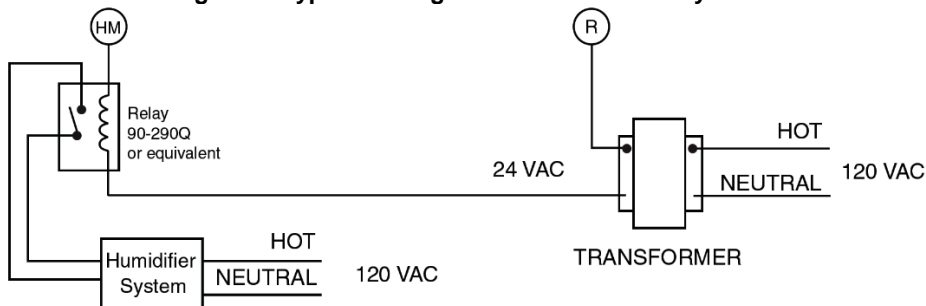
**Figure 4: Typical Single Stage AC**



**Figure 5: Two Stage**

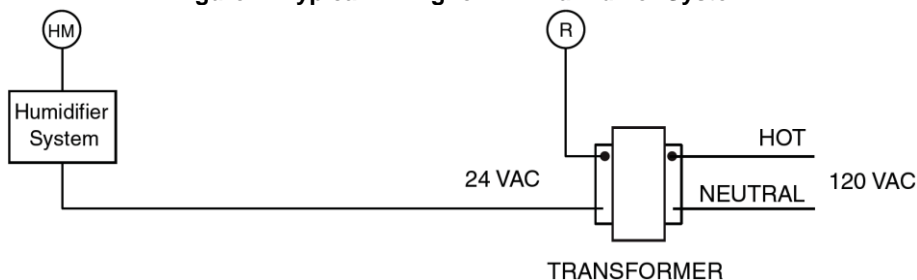


**Figure 6: Typical Wiring for 120V Humidifier System**



(Refer to furnace instructions for humidity information)

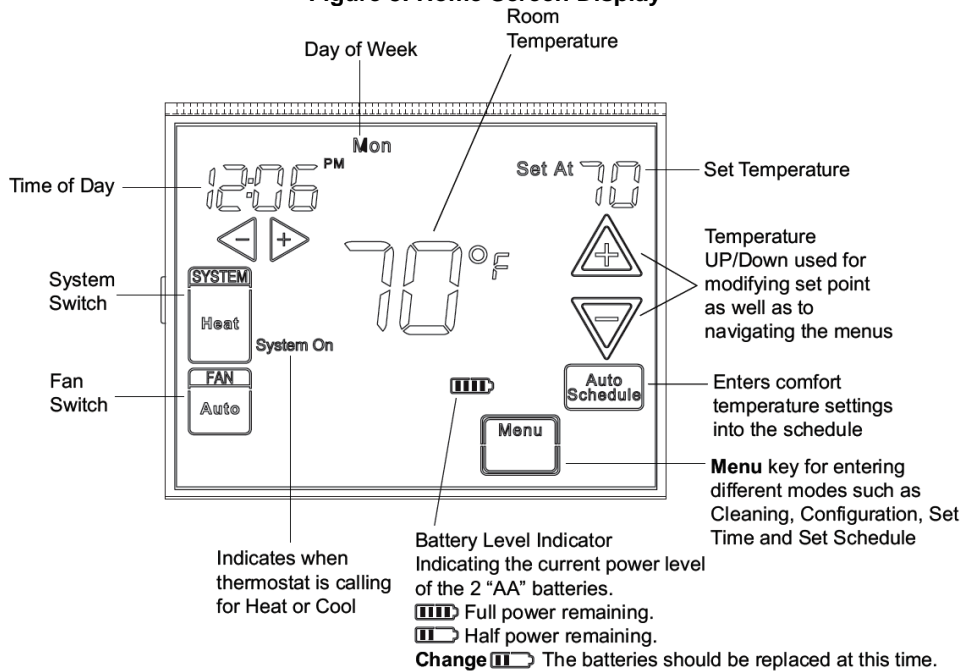
**Figure 7: Typical Wiring for 24V Humidifier System**



## 7-THERMOSTAT QUICK REFERENCE

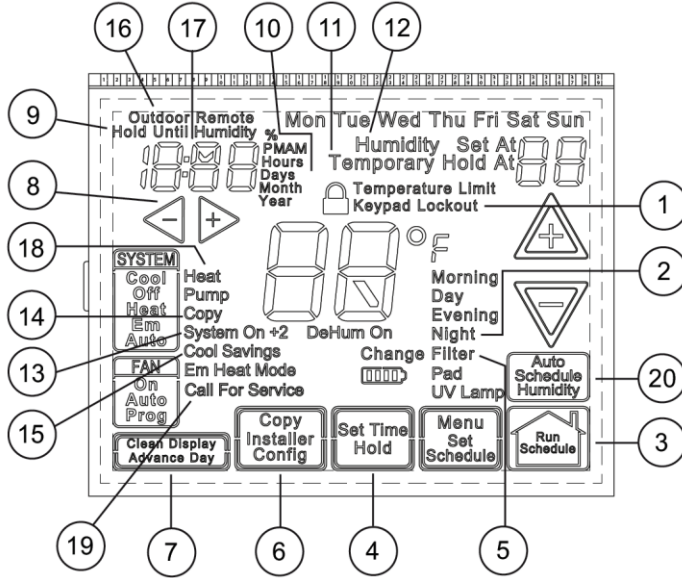
### 7.1- HOME SCREEN DESCRIPTION

**Figure 8: Home Screen Display**



## 7.2- PROGRAMMING AND CONFIGURATION ITEMS

Figure 9: Programming & Configuration Items







- 1 Displays and “Keypad Lockout” when in keypad lockout mode.  
Displays and “Temperature Limit” and “Keypad Lockout” when limited range is activated and locked.  
Displays only “temperature Limit” when limited range is activated.
- 2 Indicates period of day being programmed.
- 3 RUN SCHEDULE (run program) key.
- 4 SET TIME key or HOLD temperature key.
- 5 Displays “Change Filter”/“Change Pad”/“Change UV Lamp” when the system has run for the programmed filter/humidity pad/UV lamp time period as a reminder to change or clean your filter/humidity pad/UV lamp.
- 6 COPY key or INSTALLER CONFIG key.
- 7 CLEAN DISPLAY key allows 30 seconds to wipe off the display or ADVANCE DAY key for programming.




















- 8 Used in programming menu to set time and in configuration menu to change selections.
- 9 “Hold Until” indicates the time when a temporary hold period will end.
- 10 “Hours” and “Days” displays during steps in installer configuration.
- 11 The words “Hold At” are displayed when the thermostat is in the **HOLD** mode. “Temporary Hold At” is displayed when the thermostat is in a temporary **HOLD** mode.
- 12 “Humidity” indicates that the “Set At” display is humidity Setpoint.
- 13 “System On” indicates when heating or cooling stage is energized.
- 14 “Copy” indicates the copy program feature is being used during programming.
- 15 A steady “Cool Savings” display indicates the feature is enabled in the installer menu. A flashing “Cool Savings” display indicates the feature is active.
- 16 “Remote” indicates that the indoor remote temperature sensor is being accessed. “Outdoor Remote” indicates that the outdoor remote temperature sensor is being accessed.
- 17 Display time, remote temperature or humidity.
- 18 “Heat Pump” displays when the system configuration is set to HP1/HP2.
- 19 “Call For Service” indicates a fault in the heating/cooling systems. It does not indicate a fault in the thermostat.
- 20 **Auto Schedule** key for Auto Schedule function.



## 8-INSTALLER/CONFIGURATION MENU

To enter the menu: Press the Menu touch key. Press and hold for 5 seconds the Installer Config touch key. When the key is released the display will show menu item #1 in the table below. Press  to advance to the next menu item or  to return to a previous menu item. Press  or  to change a menu item.

**Table 4: Configuration Menu**

Menu Reference Number	Programmable	Norma	Press Button	Displayed (Factory Default)	Press or to select from listed options	Comments
1	1	1		MS 2	HP 1, HP 2, SS 1	Selects Multi-Stage (MS 2, No Heat Pump), Heat Pump 1 (HP 1, 1 compressor), Heat Pump 2 (HP 2, 2 compressor or 2 speed compressor), or Single Stage.
2	2	2		(GAS)	ELE	GAS setting: furnace controls blower. ELE setting: thermostat controls blower.
3	3	3		Days, (7) P	0	Programs per week. (5 = 5+1+1 day, 0 = normal mode)
4	4	NA		PS (4) Morning, Day, Evening, Night	2 Day, Night	Program periods per day. 4 = Morning, Day, Evening, Night 2 = Day, Night
5	5	4		Cool-Off-Heat-Auto	Cool-Off-Heat, Off-Heat, Cool-Off	System switch configuration in non heat pump mode.
				Cool-Off-Heat-Em-Auto	Cool-Off-Heat-Em, Off-Heat-Em, Cool-Off	System switch configuration, heat pump mode.
6	6	NA		E (On)	OFF	Selects Energy Management Recovery, E (with programming option on)
7	7	5		Cr, Heat (FA)	SL	Selects Adjustable Anticipation, cycle rate, Heat
8	8	6		Cr, Cool (FA)	SL	Selects Adjustable Anticipation, cycle rate, Cool
9	9	7		Cr/AU, Em (FA)	SL	Selects Adjustable Anticipation, cycle rate auxiliary, (This item is only to appear if HP 1 or HP 2 is selected above).
10	10	8		CL (OFF)	On	Selects Compressor Lockout.
11	11	9		dL (On)	OFF	Selects Continuous Display backlight & intensity.
12	12	10		dL (LO)	HI	Selects Backlight Intensity.
13	13	11		0	4, LO to 4, HI	Selects Adjustable Ambient Temperature Display [range -4 (LO) to +4 (HI)].
14	14	12		°F	°C	Selects °F/°C Display (temperature units in Fahrenheit or Celsius).
15	15	13		b (On)	OFF	Selects audible Beeper On/Off.
16	16	14		dS (On)	OFF	Selects Daylight Saving Time calculation.
17	17	15		AS, Heat (OFF)	On	Selects Automatic Schedule for comfort temperature Programming, heat mode.
18	18	16		AS, Cool (OFF)	On	Selects Automatic Schedule for comfort temperature Programming, cool mode.
19	19	17		CS, (OFF) Cool Savings	1-2-3-4-5-6	Selects Cool Saving Feature & amount.
20	20	18		HL, Heat (99)	62-98	TEMPERATURE LIMIT, HEAT (max. heat set point).
21	21	19		LL, Cool (45)	46-82	TEMPERATURE LIMIT, COOL (min. cool set point).

22	22	20	⚠	OFF, Keypad Lockout	L (total), P (partial), Temperature Limit (limited temperature range)	Selects Keypad Lockout.
			⚠	000	001-999	Selects Keypad Lockout Combination (active only if keypad Lockout is selected).
23	23	21	⚠	FS, Heat (On)	OFF	Fast second stage of heat (not available if SS1 is selected above).
24	24	22	⚠	FS, Cool (On)	OFF	Fast second stage of cool (not available if SS1 or HP1 is selected above).
25	25	23	⚠	Remote (OFF)	On	Remote temperature sensor, enable/disable.
			⚠	In, Remote	Outdoor Remote	Remote temperature sensor (Indoor/Outdoor).
			⚠	LS (On)	OFF	Local temp. Sensor enable/disable (only when Indoor Remote is selected On).
26	26	24	⚠	dF (05)	5-50	Selects Dual Fuel setpoint (°F) with outdoor sensor available. (This item appears if HP of HP2 is selected and outdoor sensor is installed and enabled.)
			⚠	Cd (15)	0-99	Selects compressor delay in seconds. (This appears if dF is selected higher than 5.)
27	27	25	⚠	AO (80)	79-35	Selects Auxiliary Heat cut out temperature. This item appears if HP1 or HP2 is selected and outdoor sensor is installed and enabled.
28	28	26	⚠	CA (OFF)	On	Selects Comfort Alert function On or Off
29	29	27	⚠	Hd (OFF)	On	Selects Humidity Display alternate with time.
30	30	28	⚠	Humidity H1, OD	-20-20 -18	Selects Humidity Display adjustment.
31	31	29	⚠	Hr (OFF)	LO, HI	Selects Auto Humidity reduction.
32	32	30	⚠	AH (OFF)	H, C, A	Selects Automatic Humidification.
33	33	31	⚠	OC (OFF)	On	Selects Optimum Comfort feature.
34	34	32	⚠	Change UV Lamp (OFF)	On	Selects Change UV Lamp feature.
			⚠	350 Days	25-1975	Change UV Lamp duration days.
35	35	33	⚠	Change Pad (OFF)	On	Selects Change Humidifier Pad feature.
			⚠	1000 Hrs	25-1975	Change Humidifier Pad duration hours.
36	36	34	⚠	OFF Change Filter	On	Selects Change Filter feature.
			⚠	200 Hours	25-1975	Change Filter duration hours.

1. This control can be configured for:  
MS2 – Multi-Stage System (2 heat/2 cool)  
default HP1 – Heat Pump with one stage of compressor (2 heat/1 cool)  
HP2 – Heat Pump with two stage compressor or two compressor system, Gas or Electric backup; (Dual Fuel see menu item 35) (3 heat/2 cool)

SS1 – Single Stage System (3 wire zone see Wiring diagrams page 5)

2. **GAS or Electric (ELE) fan operation.** If the heating system requires the thermostat to energize the fan, select ELE. Select GAS if the heating system energizes the fan on a call for heat. Note: Resetting the thermostat switches the option too .

3. **Programs per week** – This control can be configured for 7 independent day or 5/1/1 day programming or normal modes. Default is 7-day mode. The display indicates "7 Days" as default. Other options "5 Days" or "0 Days" can be selected by pressing touch keys,  $\triangleright$  or  $\triangleleft$ . If "0 Days" is selected for normal mode, the step for EMR will be skipped, as this feature will not be available in this mode.
4. **Program Steps per day** – This control can be configured for 4 or 2 program steps per day. Default is "4 PS" and can be toggled between 4 PS and 2 PS by pressing the  $\triangleright$  or  $\triangleleft$  touch keys.
5. **System Switch Configuration (MS2/SS1)** – This thermostat is configured for Heat and Cool with Auto changeover default (Cool-Off-Heat-Auto). Can be configured as Heat & Cool (Cool-Off-Heat), or Heat Only (Off-Heat), or Cool Only (Cool-Off). When the control is in heat pump configuration (HP1/HP2), the system switch configuration will have an additional mode available namely, Em for Emergency Mode.
6. **Energy Management Recovery (EMR)** – (This step is skipped if configured as normal mode.) When set to "On", it causes the thermostat to start heating or cooling early to make the building temperature reach the program setpoint at the time you specify.
7. 8 & 9. **Cycle Rate Selection** – The factory default setting is fast cycle (FA Cr) in all modes (Heat, Cool, Em). To slow cycling (SL, Cr), press touch keys  $\triangleright$  or  $\triangleleft$  toggle between FA & SL. The cycle rates are as below different selections:

Mode	Fast rate	Slow rate
Heat	0.6°F 90.33°C	1.2°F (0.67°C)
Cool	1.2°F (0.67°C)	1.7°F (0.94°C)
Em	1.2°F (0.67°C)	1.7°F (0.94°C)



- 10 **Select Compressor Lockout (CL)** – Selecting CL On will cause the thermostat to wait 5 minutes between cooling cycles. This is intended to help protect the compressor from short cycling. Some of the newer compressors have already got a time delay built in and do not require this feature to be activated in the thermostat. Your compressor manufacturer can tell you if this lockout feature is already present in their system. When the thermostat compressor time delay is activated, it will flash the set point for up to



five minutes.

- 11 **Select Continuous Backlight** – In low lighting conditions, display backlight improves the display contrast. When C terminal is connected, selecting dL On will turn the backlight on continuously. Selecting dL Off will turn the backlight on momentarily after any key is pressed. When C terminal is not powered (battery only), dL On enables the momentary backlight whenever a key is pressed.
- 12 **Select Backlight Intensity** – This thermostat has the ability to provide two selectable intensities of the back light: HI and LO. Using  $\triangleright$  or  $\triangleleft$  touch keys you can toggle the selection between HI and LO.
- 13 **Select Temperature Display Adjustment 4 LO to 4 HI** This allows you to adjust the room temperature display by an amount in the range of -4°F (-2.22°C) to +4°F (+2.22°C) in 1° steps by using the  $\triangleright$  or  $\triangleleft$  touch keys. Your thermostat was accurately calibrated at the factory, however you have the option to change the display temperature value to match your previous thermostat, if you so prefer.
- 14 **Select °F or °C** – Select the desired temperature unit by pressing  $\triangleright$  or  $\triangleleft$ . Factory default is °F.
- 15 **Select Audio Prompting (Beeper) On or Off** – Factory default setting is on (b, On). If you wish to turn off the beeper select OFF.
- 16 **Select Daylight Saving Time Calculation** – This feature will allow the thermostat to calculate the DST. Automatically and apply it to the Real Time Clock display. Default On. Use  $\triangleright$  or  $\triangleleft$  touch keys to select the feature, OFF.
- 17 & 18 **Select Automatic Schedule** – With just one touch of the Auto Schedule key this feature allows you to pro-gram a desired comfort temperature into all the program periods along with a 6°F set back for night periods of both Heat and Cool programs. Factory default is "On" for both. When Heat AS On and Cool AS On are activated while in Heat or Cool mode, select desired setpoint temperature and press Auto Schedule. Auto Schedule will flash, press it again to copy. This value will be copied into all the morning, day and evening program periods. The night program periods will be


with a 6°F (3.33°C) set back.



**19 Select Cool Savings™** – With Cool Savings™ enabled, the thermostat will make small adjustments to the sensed temperature during periods of high demand to reduce AC system running time and save energy. When the cooling system has been running for more than 20 minutes, humidity in the home will be lower and a higher temperature will feel comfortable. After 20 minutes of run time, the thermostat will start decreasing the sensed temperature in steps of less than one degree as the system continues to run. These adjustments will eventually cause the system to satisfy the thermostat to turn the system off and reduce the energy consumption. When the Cool Savings™ feature is active and making adjustments, the display will flash “CoolSavings”. The amount of the adjustments to the sensed temperature is dependent on the Cool Savings™ value that is set, 1 being the least adjustment and 6 being the most adjustment. With this feature set to OFF, no change will occur when the AC system is continuously running during the periods of high demand. Periods of high demand will normally occur during the late afternoon and early evening on the hottest days of the summer. As demand lessens the adjustments to sensed temperature are reversed until sensed temperature returns to normal and “CoolSavings” no longer flashes.

**20 Heat Temperature Limit Range** – This feature adjusts the highest setpoint temperature for heat. The default setting is 99°F (37.2°C). It can be changed between 62°F (16.7°C) and 98°F (36.7°C) by pressing the  or  key. The “Temperature Limit” icon will be displayed to the left of your setpoint temperature when using this feature. The “Temperature Limit” icon will flash if an attempt is made to adjust the temperature beyond the range selected.



**21 Cool Temperature Limit Range** – This feature adjusts the lowest setpoint temperature for cool. The default setting is 45°F (7.2°C). It can be changed between 46°F (7.8°C) and 82°F (27.8°C) by pressing the  or  key. The “Temperature Limit” icon will be displayed to the left of your setpoint temperature when using this feature. The “Temperature Limit” icon will flash if an attempt is made to adjust the temperature beyond the range selected.

**22 Keypad Lockout** – This step allows you to select the type of lockout or limited range security required. If no lockout or limited range

security is required, press  to advance the menu.


Three security settings are available in this menu item. Use the  or  keys to select the lockout desired. Lockout selections are:

“Keypad Lockout” and “L” = Total Lockout. Total Lockout locks all keys

“Keypad Lockout” and “P” = Partial Lockout. Partial Lock-out allows only the  or  keys to operate within your set temperature limits.


“Temperature Limit/Keypad Lockout” prevents changing the temperature limits in the Configuration Menu.



**Keypad Lockout Combination Number Selection.** Display will read “OFF” “Keypad Lockout”.

Skip this step and continue through the configuration remainder of the menu items if you require an Air Filter Change out indicator, UV Light indicator, or Humidifier Pad Change out indicator by pressing the  button to advance.


Return to this point when you are ready to start your selected lock-out and continue by:

Pressing  or  keys to select ON.


Press . Display will read “000”.

Pressing  or  keys to select your keypad lockout combination number. Note: “000” is not a valid combination choice.

Record the number you select for future use.

Press  to exit the menu. The security feature you select will start in 10 seconds. The system button will remain active for 10 seconds to allow setting Heat, Off, Cool or Auto.

**23 & 24 Select Fast Second Stage ON or OFF**

– In the run mode, with the fast Heat feature enabled (FA Heat On), if the Heat setpoint temperature is manually raised by 3°F (1.7°C) or more above the actual temperature using  the second stage will energize immediately. With FA OFF, second stage will not energize until the setpoint temperature is 1°F (0.56°C) or more above actual temperature for more than ten minutes. The Fast Cool feature (FA Cool) provides the same controls when the setpoint temperature is lowered.

**25 Select Remote Temperature Sensor** – This control allows one wired remote temperature sensor (indoor or outdoor) be connected to it and indicates the measured temperature in clock digits. This menu enables you to select the remote sensor and also configure it as indoor or outdoor temperature sensor. Factory default is off. Select Remote On and Remote in (for indoor) or Outdoor Remote.

Local Temperature Sensor disable – This is applicable only when indoor remote temperature sensor is enabled. Factory default is On LS. You can make it Off LS if you desire by using or touch keys. Then, only the indoor remote temperature reading will be used for control.

- 26 **Select Dual Fuel Feature Using Outdoor Sensor (dF)** – This feature is applicable only in heat pump modes and with an outdoor sensor installed and enabled in step 25. The thermostat will use the outdoor sensor temperature to determine when to switch to gas heat and shut down the compressor.

**Select DF setting (dF)** – dF default is 5. Select the setting for outdoor temperature in the range of 5o to 50o. When the outdoor temperature goes below the selected temperature, the gas heat will begin.

**Select Compressor Delay (Cd)** – If dF is selected higher than 5, after the auxiliary heat is turned on, the compressor(s) shut down is delayed for the time selected (in seconds). This delay is factory set to 60, but can be set in the range of 0 to 99.

- 27 **Select Auxilliary Off (AO)** – Select the temperature that will inhibit the auxiliary heating stage. As long as the outdoor temperature is above the selected temperature, the auxiliary heat will not turn on. The default setting is 60°, but can be set in the range of 35 ° to 80°.


- 28 **Comfort Alert (CA)** – Selecting "CA On" enables the "Call for Service" indication whenever "L" input-malfunction or compressor malfunction is active.



- 29 **Humidity Display (Hd)** – Selecting HD On enables the display to alternately show the current time and the humidity. If HD is selected OFF, the display will not show the humidity.

- 30 **Adjustable Humidity Display** – The display will show the ambient humidity and 00 (default). The setting can be changed from -20 and LO to 20 and HI. The displayed humidity will change as the offset is changed. In Run mode, the displayed humidity will be the ambient humidity adjusted by the setting selected.

- 31 **Auto Humidity Reduction (HR)** – This feature automatically lowers humidity setting when the outside temperature drops to prevent the

interior windows/walls from reaching the dew point where water condenses on surfaces. This feature default is OFF. It can be changed to select LO (low humidity reduction) or HI. To achieve automatic humidity reduction, the thermostat lowers the humidity when furnace cycles are long. When the outside temperature rises, it increases humidity. "LO" indicates a low amount of humidity reduction.

32 **Automatic Dehumidification (AH)** – This feature if enabled allows for humidification independent of a call for heating – useful in arid climates where addition humidification in heating and/or cooling is desired. If enabled, will energize the humidifier and circulator blower ("G" terminal and the "HM" terminal) if the actual humidity is below the humidity set point. The display indicates AH. Pressing the  key will cycle the display from OFF to H (feature enabled in Heat mode) to C (feature enabled in Cool mode) to A (feature enabled to Auto mode) and back to OFF.

- 33 **Programmable Dehumidification optimal Comfort Mode (OC)** – This item can be selected to OC (Optimal Comfort mode), or OFF. When Optimal Comfort (OC) is enabled, this feature automatically reduces indoor humidity with a call for Cooling if humidity is 2% above humidity setpoint. Humidity is set by pressing the Humidity key when in the appropriate mode, in this case Cooling, and pressing the  or  keys to set desired humidity (range 40% to 95%) level followed by pressing Humidity key again. This dehumidification feature uses less energy by maintaining temperature and dehumidifying only when a call for Cooling is required.

- 34 **Select Change UV Lamp Time** – This feature allows the thermostat to display the words "**Change UV Lamp**" (Call for Service of UV bulb) after a set time of UV bulb operation. This is a reminder to maintain your UV system at optimum level of operation. When enabled, the factory set interval for "**Change UV Lamp**" to be displayed is 350 days of UV bulb operation and can be set between 25 to 1975 days in 25 day increments. This should be adjusted with respect to the bulb's recommended maintenance schedule. When "**Change UV Lamp**" is displayed, you can clear it by pressing Clean Display

- 35 **Select Change Humidifier Pad Time** – This feature allows the thermostat to display the words "Change Pad" after a set time of

humidifier operation. This is a reminder to maintain or clean your humidifier. The factory set interval for "Change Pad" to be displayed is 200 hours of humidifier operation and can be set between 25 to 1975 hours in 25 hour increments. This should be adjusted with respect to the humidifier's recommended maintenance schedule.

When "Change Pad" is displayed, you can clear it by pressing Clean Display.

- 36 **Select Change Filter Run Time** – This feature allows thermostat to display "**Change Filter**" after a set time of blower operation. This is a reminder to change or clean your air filter. This time can be set from 25 to 1975 hours in 25 hour increments. A selection of OFF will cancel this feature. When "**Change Filter**" is displayed, you can clear it by pressing Clean Display. In a typical application, 200 hours of run time is approximately 30 days.

## 9-OPERATING YOUR THERMOSTAT

### 9.1- CHECK THERMOSTAT OPERATION

#### NOTE

To prevent static discharge problem, touch side of thermostat to release static build-up before touching any keys.

If at any time during testing your system does not operate properly, contact a qualified service person.

### 9.2- FAN OPERATION

If your system does not have a G terminal connection, skip to **Heating System**.

1. Turn on power to system.
2. Press FAN key to **ON** position. The blower should begin to operate.
3. Press FAN key to **AUTO** position. The blower should stop immediately.



#### CAUTION

Do not allow the compressor to run unless the compressor oil heaters have been operational for 6 hours and the system has not been operational for at least 5 minutes.

### 9.3- HEATING/HUMIDIFIER

1. Press SYSTEM key to select HEAT. If the auxiliary heating system has a standing pilot, be sure to light it.
2. Press  $\Delta$  to adjust thermostat setting setting to 1°(0.5°C) above the room temperature. The heat pump system should begin to operate. The display should show "**System On**". However, if the system configuration is set to HP1 or HP2 and setpoint temperature display is flashing, the 5 minute compressor lockout feature is operating (see Configuration menu, item 11).
3. Adjust temperature setting to 3°F (1.7°C) above room temperature. If your system configuration is set at MS2, HP1 or HP2, the auxiliary heat system should begin to operate and the display will show "**System On +2**".
4. Press  $\nabla$  to adjust the thermostat below room temperature. The heating system should stop operating.

To check the humidifier when **System On** appears and the heating system is running press the **HUMIDITY\*** button once. Press  $\Delta$  to adjust the humidity 2% or more above the room humidity level. **Hum On** will appear indicating it is calling for the humidifier.


\*NOTE: If Auto Schedule is displayed instead of Humidity, Auto Schedule must be turned off in the Configuration Menu.


### 9.4- EMERGENCY MODE

Applies only to Heat Pump Systems

**Emergency Heat (System EM Position)** bypasses the Heat Pump to use the heat source wired to terminal **W/E, W2** on the thermostat. **EM** is typically used when compressor operation is not desired, or you prefer back-up heat only.



1. Press SYSTEM key to select **EM**. "**EM Heat Mode**" will flash on the display.
2. Press  $\Delta$  to adjust thermostat setting above room temperature. The Emergency heating system will begin to operate. The display will show "**System On**" flashing "**EM Heat Mode**" and "Heat" to indicate that the Emergency system is operating.
3. Adjust temperature setting to 3°F (1.7°C) above room temperature. Any additional stages of auxiliary heat should begin to operate and the display will show "**System On +2**".


4. Press  to adjust the thermostat below room temperature. The heating system should stop operating.


**CAUTION**

**To prevent compressor and/or property damage, if the outdoor temperature is below 50°F (10°C), DO NOT operate the cooling system**

## 9.5- COOLING/DEHUMIDIFIER

1. Press SYSTEM to select **COOL**.
2. Press  to adjust the thermostat setting below room temperature. The blower should come on immediately on high speed, followed by cold air circulation. The display should show "**System On**". If the setpoint temperature display is flashing, the compressor lockout feature is operating (see Table 4: Configuration Menu, item 5).
3. Adjust temperature setting to 3°F (1.7°C) below room temperature. The second stage cooling should begin to operate and the display should show "**System On +2**".
4. Press  to adjust the temperature setting above room temperature. The cooling system should stop operating.

To check the dehumidifier when "**System On**" appears and the cooling system is running press **HUMIDITY\*** button once. Press  to adjust the humidity 2% or more below the room humidity level. "**DeHum On**" will appear indicating it is calling for the dehumidification.

If the room humidity is lower than the adjustment range, press to 40% and hold it for four seconds. This will force the "**DeHum On**" for one complete cooling cycle to test the dehumidification equipment.

After adjusting the humidity setting the display will return to temperature in approximately 10 seconds. To switch the display back to temperature immediately after adjusting humidity setting press **HUMIDITY** again.

**\*NOTE:** If Auto Schedule is displayed instead of Humidity, Auto Schedule must be turned off in the Configuration Menu.

## 9.6- CHOOSE THE FAN SETTING (AUTO OR ON OR PROG)

There are two fan features on the R02P030:

1. **Fan Auto/On – Traditional Fan Settings**  
Press **Fan** to select **Auto** or **On**. The most commonly used setting is **Auto**. **Fan Auto** runs the fan only when the heating or cooling system is operating. Selecting **Fan On** runs the fan continuously for increased air circulation or to allow additional air cleaning if the system is equipped with an Electronic Air Cleaner.
2. **Fan On Prog. – Programmable Fan FAN On Prog** indicates that a time period has **FAN Prog** selected in the Set Schedule mode (see Programmable Fan Option). The fan will run continuously through the period until the next period begins. To override **FAN On Prog**, press the **FAN** key to select **Auto** for the fan to run only when the heating or cooling system is operating.

## 9.7- CHOOSE THE SYSTEM SETTING (COOL, OFF, HEAT, EM, AUTO)

Press the SYSTEM button to select:

**Cool:** Thermostat controls only the cooling system.



**Off:** Heating and Cooling systems are off.

**Heat:** Thermostat controls only the heating system.

**Em:** Setting is available only when the thermostat is configured in HP1 or HP2 mode.

**Auto:** Auto Changeover is used in areas where both heating and cooling may be required on the same day. **AUTO** allows the thermostat to automatically select heating or cooling depending on the indoor temperature and the selected heat and cool temperatures. When using **AUTO**, be sure to set the Cooling temperatures more than 1° F (0.55°C) higher than the heating temperature.

## 9.8- MANUAL OPERATION FOR NORMAL MODE THERMOSTATS

Press the SYSTEM button to select Heat or Cool and use the  or  buttons to adjust the temperature to your desired setting. After selecting your desired settings you can also press the SYSTEM button to select **AUTO** to allow the thermostat to automatically change between Heat and Cool.

## 9.9- MANUAL OPERATION (BYPASSING THE PROGRAM) PROGRAMMABLE THERMOSTATS

Press ▲ or ▼ and the HOLD button and adjust the temperature wherever you like. This will override the program. The HOLD feature bypasses the program and allows you to adjust the temperature manually, as needed. Whatever temperature you set in HOLD will be maintained 24 hours a day, until you manually change the temperature or press Run Schedule to cancel HOLD and resume the programmed schedule.

### 9.10- PROGRAM OVERRIDE (TEMPORARY OVERRIDE)

Press ▲ or ▼ buttons to adjust the temperature. This will override the temperature setting for a (default) four hour override period. The override period can be shortened by pressing ◀ or lengthened by pressing ▶. Program Override period can range from 15 minutes to 7 days.

**Example:** If you turn up the heat during the morning program, it will be automatically lowered later, when the temporary hold period ends. To cancel the temporary setting at any time and return to the program, press Run Schedule. If the SYSTEM button is pressed to select AUTO the thermostat will change to Heat or Cool, whichever ran last. If it switches to heat but you want cool, or it changes to cool but you want heat, press both ▼ or ▲ buttons simultaneously to change to the other mode.

### 9.11- SPECIAL TEST MODE FOR PWM (V) OUTPUT (INSTALLER FUNCTION ONLY)

The PWM (V) output controls the modulating gas valve. Amplitude of this signal is about 10 VDC, frequency is 1 HZ and the pulse width is variable 350 to 950 in steps of 50 msec.

To activate the modulating test mode, press and hold the Installer Config touch key until the display changes to show dC (in actual temperature digits) and 05 (default) in clock digits (at least 10 seconds). If the touch key is released before the display changes the test mode will not be activated and the installer menu mode will be active. On entering the modulating test mode, the display (05) will indicate the duty cycle of 5% (pulse width of 50 msec) corresponding to no call for heat.

Press ▶ key to change the display to 35 (duty cycle 35%). The W output will energize and within one

second the pulse width modulated V output will also be activated with a pulse width of 350 msec.

Use ▶ or ◀ touch keys to increase or decrease the pulse width in steps of 50 milliseconds (5% change in duty cycle). The maximum duty cycle is 95% (maximum pulse width of 950 milliseconds).

This special test mode will be exited by pressing Run Schedule touch key or when there is no keypad activity for over 60 minutes.

### 9.12- SET CURRENT TIME AND DAY

1. Press Menu key to enter installer menu. Then press Set Time once to indicate hour & A or P designation in clock display
2. Press and hold either the ▶ or ◀ touch key until you reach the correct hour and A or P designation.
3. Press Set Time again to display minutes only in clock display.
4. Press and hold either the ▶ or ◀ touch keys until you reach the correct minutes.
5. Press Set Time once again to display year.
6. Press and hold either the ▶ or ◀ touch key until you reach the correct year.
7. Press Set Time once again to display month.
8. Press and hold either the ▶ or ◀ touch key until you reach the correct month.
9. Press Set Time once again to display date of the month along with day of the week at top row (which is automatic).
10. Press and hold either the ▶ or ◀ touch key until you reach the correct day of the month. The correct day of the week is displayed at the top row.
11. Press Run Schedule once; now the display will show the correct time and room temperature.

## 10- PROGRAMMING

### 10.1- AUTOMATIC DAYLIGHT SAVING CALCULATION

The Real Time Clock will adjust automatically for daylight savings time in the following manner:

Increment one hour at 2 AM on the second Sunday of March and decrement one hour at 2AM on the first Sunday of November.

The daylight saving feature can be enabled or disabled in installer



After entering installer configuration mode, momentarily press  $\blacktriangle$  or  $\blacktriangledown$  touch key until the display indicates dS (in actual temperature digits) and on (default – in clock digits).

$\blacktriangle$  and  $\blacktriangledown$  keys will toggle display and operation from On to OFF.

## 10.2- PROGRAMMABLE FAN OPTION

In the Set Schedule (programming mode) pressing **Fan** will alternate the fan setting between **FAN Auto** and **FAN Prog**.

**FAN Auto** runs the fan as needed with the heating or cooling. **FAN Prog** programs the fan to run continuously for the heating or cooling time period you are programming.

Example: Press the **SYSTEM** key to select Heat.

Press the **Menu** key once to display **Set Schedule**.

Press **Set Schedule** once to display the 1st heating program period. The time and temperature for this period will show on the display. Press the **FAN** key until it displays **FAN Prog**. The fan is now programmed to run continuously for this time period. The fan can be programmed for any or all time and temperature settings in heating and cooling. To cancel program fan for a time period, enter the heating or cooling program (Menu, Set Schedule) and advance to the time/temperature period you want to cancel. Press the fan key and **FAN Prog** will change to **FAN Auto**.

## 10.3- WIRE REMOTE TEMPERATURE SENSING

One remote temperature sensor can be installed indoor or outdoor and connected to the thermostat by a maximum cable length of 100 meters (300 feet). Terminals +, S and - on the terminal block allow connection of the remote sensor. The thermostat must have 24 VAC Common connection to terminal C for the remote sensor to operate. The remote sensor can be enabled or disabled in the Installer/Configuration menu, item 25.

When remote sensor, Remote, is selected Off (factory default), no remote sensor is enabled. When remote sensor is selected On, the next step is to select the remote as indoor, Remote In, or outdoor, Remote Outdoor. If the remote is selected as Remote In, an additional step will be to select if the temperature shown on the display will be from the thermostat, LS On, or the remote sensor Ls Off.

In normal operation, when a remote sensor is enabled the time digits of the display will alternate between the

time and the remote temperature for three seconds each. Above the remote temperature will be Remote, for indoor sensor or Outdoor Remote, for outdoor sensor. If the remote sensor is an indoor sensor and the local display has been disabled, the temperature displayed as the room temperature will be the remote sensor temperature.

Sensing range:

Outdoor temperature range is -40 to 140 °F (-40 à 60°C)

Indoor temperature range is 32 °F to 99 °F (0 à 37.2°C)

## 10.4- WEIGHT OF REMOTE READING

The thermostat is designed to receive the temperature of the indoor remote sensor and average, or weight it with the local sensor in the thermostat for each program period. The averaging will be active only when the local sensor and the indoor remote sensor are both functional and enabled in the Installer/Configuration menu.

When the thermostat is in the Set Schedule mode, the weight of the indoor sensor will be shown in the current temperature digits of the display. The weight will show as A2 (average and default), H4 (high) or L1 (low). Pressing the  $\blacktriangle$  and  $\blacktriangledown$  keys at the same time will change the weight for the program period. The weight of the local sensor is fixed.

In normal operation of the thermostat, the current temperature displayed will be the weighted average of the local sensor and the remote sensor using the formula (local sensor weight x local sensor temperature) + (remote sensor weight x remote sensor temperature) / (local sensor weight + remote sensor weight).

Example: Local sensor temperature is 80°F (26.7°C) and the remote sensor is 70°F (21.1°C). If weight is selected H4, the average temperature of 72°F (22.2°C) will be displayed.  $(1 \times 80) + (4 \times 70) / 5 = 72^\circ$

If weight is selected A2, the average temperature of 73°F (22.8°C) will be displayed.  $(1 \times 80) + (2 \times 70) / 3 = 73.3^\circ$

If weight is selected L1, the average temperature of 75°F (23.9°C) will be displayed.  $(1 \times 80) + (1 \times 70) / 2 = 75^\circ$

The example shows that the weight selected would prioritize the overall averaged temperature between the two sensors. The high weight selection caused the remote sensor to have a higher influence in the calculated temperature average than the local sensor and the low weight selection caused the remote sensor to have less influence.

## 10.5- CALL FOR SERVICE INDICATOR

"Call for Service" indicates a compressor fault. "Call for Service" will be on continuously when the L terminal is energized. "Call for Service" will flash at the same rate as the L terminal input signal, indicating a fault code. For this indicator to be operational, menu option "CA" must be selected to "On".

## 10.6- DUAL FUEL TEMPERATURE SETPOINT

When the thermostat is configured for Heat Pump mode and an outside remote sensor is installed, the thermostat can monitor the outside temperature. When the outside temperature falls below a user selectable temperature, the thermostat will switch to gas or electrical heat and shut down the compressor. This eliminates the need for a fossil fuel kit.

The user selectable temperature is called the dual fuel temperature setpoint, dF and is set in the Installer/Configuration menu, item 26. The dual fuel temperature setpoint can be set to a temperature of 5 through 50°F (-15 à 10°C). A selection of 5 (default

setting) disables this feature and menu selection of Cd will not be available.

After the dual fuel temperature setpoint is set above 5 and **A** is pressed, a delay, Cd, can be set for compressor shutdown after the auxiliary stage is energized. This delay can be set from 0 seconds to 99 seconds to minimize the time that the system may blow cooler air until the alternate source of heat comes on. Default setting for delay is 60. When setting the delay if the **▶** or **◀** keys are held depressed, the setpoint will increase or decrease at the rate of one degree every half second for the first three seconds and double the speed after three seconds.

**Table 5: Dual Fuel Settings**

Menu Reference	Options	Setting
1	HP1 or HP2	HP1 or HP2
25	Remote	ON
		Outdoor Remote
26	DF	5-50 Selectable
27	AO	35-80 Selectable

# 11- TROUBLESHOOTING

## RESET OPERATION

**NOTE:** When thermostat is reset, installer configuration menu settings and programming will reset to factory settings. If a voltage spike or static discharge blanks out the display or causes erratic thermostat operation, you can reset the thermostat by removing the wires from terminals R and C (do not short them together) and removing batteries for 2 minutes. After resetting the thermostat, replace the wires and batteries. If the thermostat has been reset and still does not function correctly contact your heating/cooling service person or place of purchase.

**NOTE:** Be sure to review the installer configuration menu settings.

To reset the programming, clock and configuration settings, press ▲ and ▼ and the SYSTEM button simultaneously. The thermostat should go blank and then all segments will be displayed momentarily.

Symptom	Possible Cause	Corrective Action
No Heat/No Cool/No Fan (common problems)	1. Blown fuse or tripped circuit breaker. 2. Furnace power switch to OFF. 3. Furnace blower compartment door or panel loose or not properly installed. 4. Loose connection to thermostat or system.	Replace fuse or reset breaker. Turn switch to ON. Replace door panel in proper position to engage safety interlock or door switch. Tighten connections.
No Heat	1. Pilot light not lit. 2. Furnace Lock-Out Condition. Heat may also be intermittent. 3. Heating system requires service or thermostat requires replacement.	Re-light pilot. Many furnaces have safety devices that shut down when a lock-out condition occurs. If the heat works intermittently contact the furnace manufacturer or local HVAC service person for assistance. Diagnostic: Set SYSTEM Switch to HEAT and raise the setpoint above room temperature. Within a few seconds the thermostat should make a soft click sound. This sound usually indicates the thermostat is operating properly. If the thermostat does not click, try the reset operation listed above. If the thermostat does not click after being reset contact your heating and cooling service person or place of purchase for a replacement. If the thermostat clicks, contact the furnace manufacturer or a HVAC service person to verify the heating is operating correctly.
No Cool	1. Cooling system requires service or thermostat requires replacement.	Same as diagnostic for No Heat condition except set the thermostat to COOL and lower the setpoint below the room temperature. There may be up to a five minute delay before the thermostat clicks in Cooling.
Heat, Cool or Fan Runs Constantly	1. Possible short in wiring. 2. Possible short in thermostat. 3. Possible short in heat/cool/fan system. 4. FAN Switch set to Fan ON.	Check each wire connection to verify they are not shorted or touching together. No bare wire should stick out from under terminal block. Try resetting the thermostat as described above. If the condition persists the manufacturer of your system or service person can instruct you on how to test the Heat/Cool system for correct operation. If the system operates correctly, replace the thermostat.
Thermostat Setting & Thermostat Thermometer Disagree	1. Thermostat thermometer setting requires adjustment.	The thermometer can be adjusted +/- 4 degrees. See Temperature Display Adjustment in the Configuration Menu section.
Furnace (Air Conditioner) Cycles Too Fast or Too Slow (narrow or wide temperature swing)	1. The location of the thermostat and/or the size of the Heating System may be influencing the cycle rate.	Digital thermostats provide precise control and cycle faster than older mechanical models. The system turns on and off more frequently but runs for a shorter time so there is no increase in energy use. If you would like an increased cycle time, choose SL for slow cycle in the Configuration menu, step 6 (heat) or 7 (cool). If an acceptable cycle rate is not achieved, contact a local HVAC service person for additional suggestions.
Forgot Keypad Lockout Code		Press the menu button (button will disappear) and hold in for 20 seconds. This unlocks the thermostat.