

Design and installation manual

(with 2.5 inches flexible ducts in a low to medium velocity)



RIGHT-SIZED SYSTEM[®]

SMART DUCT SYSTEM[®]



Caution: Do not tamper with the unit or its controls. Call a qualified service technician.

Manufactured by:

Industries Dettson inc.
3400 Industrial Boulevard
Sherbrooke, Quebec -
Canada
J1L 1V8

TABLE OF CONTENT

1	Introduction	3
2	Operating principles	3
2.1	Operation Guidelines	5
3	Smart Duct System components (HVAC in a box) .	6
3.1	Modulating Chinook gas furnace	6
3.2	Modulating Supreme electric furnace	7
3.3	Modulating Alizé outdoor unit & indoor coil	7
3.4	Thermostat	8
3.5	Distribution Box	8
3.6	Trunks	8
3.7	2.5" branches	9
3.7.1	The saddles.....	9
3.7.2	The 2.5" flex duct.....	9
3.7.3	The collars and the diffusers.....	9
3.7.4	The returns.....	11
4	Equipment selection and smart duct design	12
4.1	Manual design procedure	12
4.2	Dettson's calculator design procedure	15
5	Installation of the diffuser and saddle with the 2.5 inches flexible duct	18
5.1	Installation of the saddle on the trunk	18
5.2	Installation of the diffuser on the wall	19
6	Design parameters summary	20
7	Inspection checklist	22

TABLE OF FIGURES

Figure 1: Throw of air in the room.....	4
Figure 2: Monitoring of a house with the Right-sized System®.....	4
Figure 3: A Chinook with a bottom base return.....	7
Figure 4: Outdoor cooling unit, Alizé.....	7
Figure 5: Dettson communicating thermostat.....	8
Figure 6: Distribution box.....	8
Figure 7: Smart Duct Trunk.....	8
Figure 8: Saddles 8" (grey) and Saddles 6" (black).....	9
Figure 9: Do not crush the flex duct.....	9
Figure 10: Do not bend the flex duct 90 deg. at the collar.....	9
Figure 11: Construction cap.....	10
Figure 12: 90 deg. Collar - White.....	10
Figure 13: 90 deg. Collar - Black.....	10
Figure 14: Diffuser.....	10
Figure 15: Blocked Diffuser.....	11
Figure 16: Straight Saddle.....	18
Figure 17: 45 deg. Saddle.....	18
Figure 18: Diffuser.....	18
Figure 19: 90 deg. Collar.....	18
Figure 20: Screw the 2.5" flex into the saddle.....	18
Figure 21: Screw the saddle on the trunk.....	18
Figure 22: Attach the collar on the wall stud.....	19
Figure 23: Install the gypsum & finish the wall.....	19
Figure 24: Screw the diffuser on the collar.....	19

1 Introduction

The trend for more efficient homes is rising. Moreover, new codes and regulations are decreasing the thermal loads of houses. It is now more common to have houses with less than 60,000 BTU/h heat load and less than 24,000 BTU/h heat gain. With that in mind and with the increasing demand from the builders in North America, Dettson is proposing the Right-Sized System®. With the Chinook modulating gas furnace which offers capacities as low as 15,000 BTU/h (between 5,736 and 14,340 BTU/h) and the Alizé modulating heat pump unit, Dettson is offering a year round solution for the low load and highly energy efficient homes.

The modulation resulting from the variable speed operation enables the Right-Sized System® to provide homes with the required load throughout a given day, the different seasons and the year. It induces long operating cycles with gentler airflow than traditional systems. A low airflow system allows the use of smaller ducts for better air mixing, air distribution and thermal comfort while offering quieter operation. The Smart Duct System uses 2.5" diameter flex ducts inside the walls to provide air conditioning. The use of the two modulating appliances, which are the Chinook gas furnace and the Alizé cooling unit, delivers conditioned air to each room. The advantages of the Smart Duct System are numerous:

For the homeowner:

- Uniform temperature distribution throughout the home (no cold or hot rooms);
- Highly efficient system;
- Quieter environment in each room;
- Healthier air with better mixing and controlled humidity.

For the builder:

- A uniform system from home to home;
- Less labor;
- Less duct leakage;
- Less SKUs;
- Easy-to-design duct system;
- Balanced system at any airflow to each room;
- Less mold issues, reduced call backs and warranty issues.

2 Operating principles

The wide range of modulation of the system in heating (40 to 100%) and in cooling (25 to 100%) will mostly provide to the home the exact heating or cooling that is required dictated from the different climate outdoor conditions. The airflow of the system modulates accordingly by feeding the Smart Duct System the proper amount of air required as per the calculated loads. This ensures that the system will run at the lowest speed that is required for the longest possible cycle. Running at these low or proper airflows makes it possible to consider a Smart Duct System with low leakage.

A traditional duct system often presents more than 20% air leakage, leaving the most distant diffuser with less than the designed airflow. With a static pressure higher than traditional ducts, it is essential to have a leak-proof duct distribution system. This Smart Duct System is designed to provide less than 5% air leakage without extra sealing work. This low leakage system combined with the proper static pressure enables to provide each diffuser the designed airflow really required to attain an optimal thermal comfort to the occupants with low level of noise.

Our furnaces are able to provide a constant airflow at static pressures up to 1.7" w.c. Concerning the air distribution design, we set the limit at 1.4" w.c. at the supply and -0.2" at the return. This limit sets the maximum CFM per diffuser at 33 CFM (@ 12' of flex duct) with 1" w.c. in the trunks (after the cooling coil). The number of diffusers is then determined by the maximum designed CFM. It is important to note that we can expect this maximum designed airflow to occur less than 5% of the time (if ever). The vast majority of the time, the system will run between 0.3" and 0.8" w.c. at the furnace supply and 0.2" to 0.6" w.c. in the trunks.

At these low airflows, the traditional air distribution system will lead to a very low throw at the grills. On the contrary, the small diffusers will induce a throw of more than 10 feet at 20 CFM. This will mix the air very effectively in the room compared to a traditional duct system where areas of the room will not be stirred.

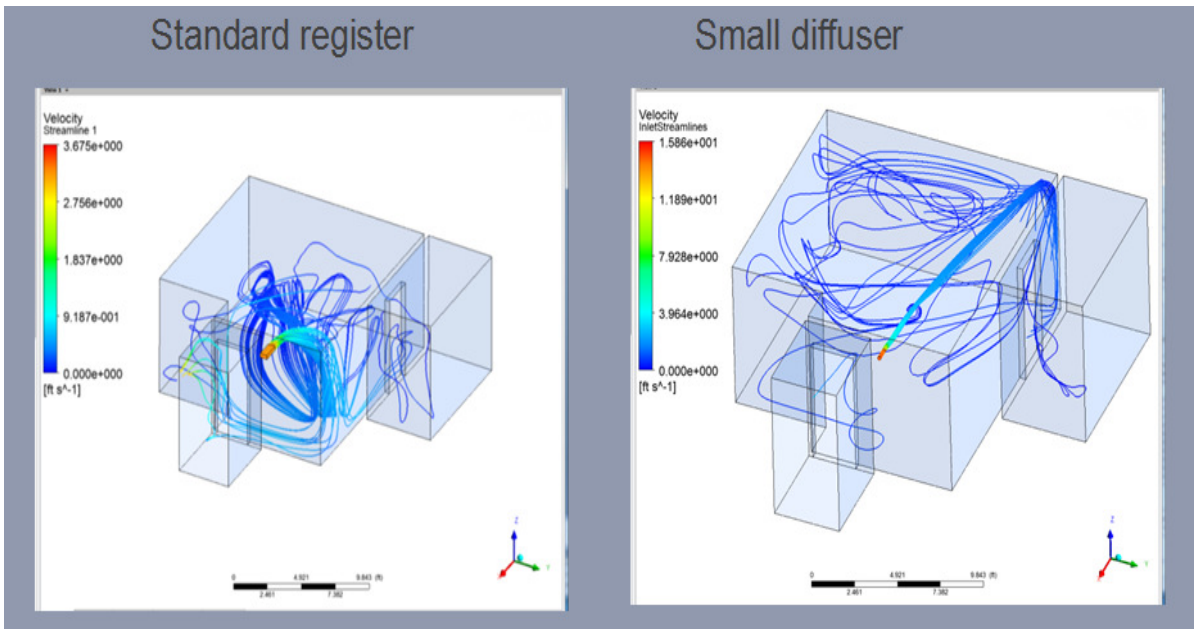

Figure 1: Throw of air in the room

Thermostat setback:

We do not recommend to program setbacks on the thermostat (lower the setpoint temperature at night, for example). While we do not believe it gives significant energy savings, it can also result in wide variations in

relative humidity. A setback will stop the furnace (as opposed to continuous cycle), thus the air is not mixing anymore and temperature/humidity variations occur with magnified amplitude. This can be observed on the graph below representing the monitoring, by a third party, of a house including the Right-Sized System®.

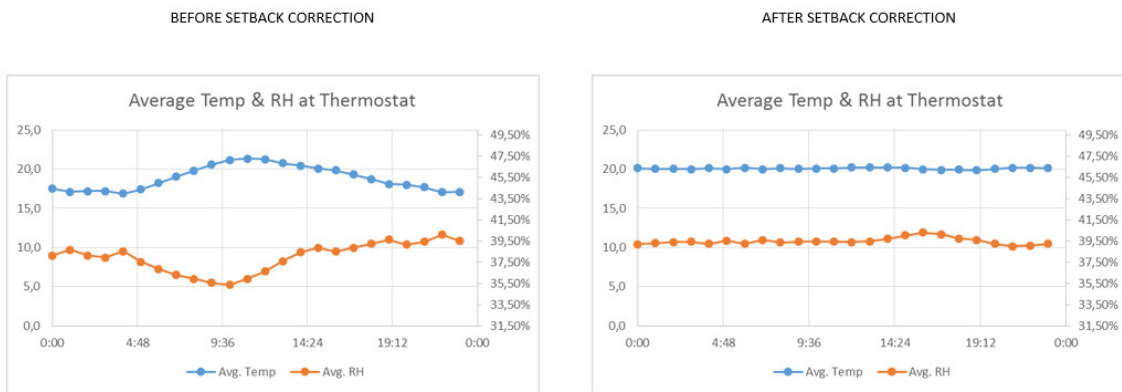

Figure 2: Monitoring of a house with the Right-sized System®

2.1 Operation Guidelines

When using our Smart Duct System, you must use the following equipment:

Furnace – Supreme Electric Furnace (Modulating Series) or Chinook Gas Furnace (Modulating Series).

Thermostat – Dettson Communicating (R02P032), except for:

- Supreme heating only: Dettson modulating thermostat (R02P030).
- Zoning: Any 2-heat/2-cool thermostat (R, C, W1, W2, Y1, Y2, G)

Ductwork – Main trunk must comply with section 3.6 and heat runs must use components specified in section 3.7.

If you choose to have an outdoor unit, it must include:

Coil – Dettson matching coil

Air Conditioner / Heat Pump – Alize heat pump or ACD outdoor unit.

Please refer to your original bill of materials to determine what size & model to use.

We are not responsible for installations that do not use Dettson-approved equipment as listed above.

3 Smart Duct System components (HVAC in a box)

The Smart Duct System is a complete HVAC system that includes the modulating furnace, the modulating outdoor heat pump, the indoor coil, the thermostat and the Smart Duct air distribution system. The air distribution system components are the distribution box, the trunks and the 2.5" diameter branches.

3.1 Modulating Chinook gas furnace

A Dettson furnace must be installed in order to use the Right-Sized System®. Indeed, the furnace is specifically designed and controlled for the Smart Duct System. The modulating Chinook gas furnace can modulate between 40% and 100% of its nominal capacity.

The following models can be chosen for this system:

Model	Heating cap.	CFM max	Max htg CFM	Min. heating	Min htg CFM	
CC015-M-V	14445	400	330	5778	85	Chinook Compact 15,000 BTU modulating, 1/3 HP, 95% AFUE, 40 to 100% modulating
C015-M-V	14595	600	360	5838	295	Chinook 15,000 BTU modulating, 1/2 HP, 95% AFUE, 40 to 100% modulating
C015-M-S	14595	859	360	5838	295	Chinook 15,000 BTU modulating, 3/4 HP, 95% AFUE, 40 to 100% modulating
C030-M-V	28860	722	420	11544	300	Chinook 30,000 BTU modulating, 1/2 HP, 95% AFUE, 40 to 100% modulating
C030-M-S	28860	1000	420	11544	300	Chinook 30,000 BTU modulating, 3/4 HP, 95% AFUE, 40 to 100% modulating
C045-M-V	43515	800	730	17406	360	Chinook 45,000 BTU modulating, 1/2 HP, 95% AFUE, 40 to 100% modulating
C045-M-S	43515	1000	780	17406	355	Chinook 45,000 BTU modulating, 3/4 HP, 95% AFUE, 40 to 100% modulating
C060-M-V	58080	1235	1000	23232	430	Chinook 60,000 BTU modulating, 3/4 HP, 95% AFUE, 40 to 100% modulating
C060-M-S	72000	1260	1200	28800	480	Chinook 75,000 BTU modulating, 3/4 HP, 95% AFUE, 40 to 100% modulating
C075-M-V	14445	400	330	5778	85	Chinook Compact 15,000 BTU modulating, 1/3 HP, 95% AFUE, 40 to 100% modulating

3.2 Modulating Supreme electric furnace

A Dettson furnace must be installed in order to use the Right-Sized System®. Indeed, the furnace is specifically designed and controlled for the Smart Duct System. The modulating Supreme electric furnace can modulate between 5% and 100% of its nominal capacity. The Supreme electric furnace allows the simultaneous operation of the furnace and the heat pump to compensate the heat pump capacity loss when outdoor temperature drops. Thus, the cooling coil shall be installed on the return of the furnace. The following models can be chosen for this system:

Model	Heating cap.	CFM max	Max htg CFM	
SUP10-M240V12	34120	1000	477	Supreme 10kW modulating, 1/2 HP ECM Motor
SUP15-M240V12	51180	1000	715	Supreme 15kW modulating, 1/2 HP ECM Motor
SUP18-M240V12	61416	1000	858	Supreme 18kW modulating, 1/2 HP ECM Motor
SUP20-M240V12	68240	1000	954	Supreme 20kW modulating, 1/2 HP ECM Motor
SUP20-M240V20	68240	1600	954	Supreme 20kW modulating, 1 HP ECM Motor
SUP23-M240V12	78476	1000	1097	Supreme 23kW modulating, 1/2 HP ECM Motor
SUP23-M240V20	78476	1600	1097	Supreme 23kW modulating, 1 HP ECM Motor
SUP25-M240V12	85300	1000	1192	Supreme 25kW modulating, 1/2 HP ECM Motor
SUP25-M240V20	85300	1600	1192	Supreme 25kW modulating, 1 HP ECM Motor
SUP27-M240V20	92124	1600	1288	Supreme 27kW modulating, 1 HP ECM Motor
SUP30-M240V20	102360	1600	1431	Supreme 30kW modulating, 1 HP ECM Motor

We recommend the use of the bottom base return for a better airflow through the furnace. With this base, the air is drawn from both side of the furnace's blower leading to a more laminar airflow and less electric consumption.



Figure 3: A Chinook with a bottom base return

3.3 Modulating Alizé outdoor unit & indoor coil

The outdoor cooling unit can modulate from 25% to 100%. Moreover, the unit is well adapted to tight environments and its side discharge type makes it easy to install the unit almost everywhere around the house. Also, this unit is very quiet for the homeowner and his neighbours with a noise level as low as 49 dB in full capacity or ventilation regime. With the Smart Duct System, the capacities of the Alizé range from 9,000 BTU/h to 36,000 BTU/h; a corresponding coil shall be installed.



Figure 4: Outdoor cooling unit, Alizé

3.4 Thermostat

The Dettson communicating thermostat is mandatory for the Right-Sized System® for proper communication between the different appliances.

The Smart Zoning System requires one (1) two-stage thermostat per zone.



Figure 5: Dettson communicating thermostat

3.5 Distribution Box

The distribution box is installed over the coil; it is pre-drilled and up to 8 trunks can be attached to it. The trunks need to be properly sealed over the distribution box.

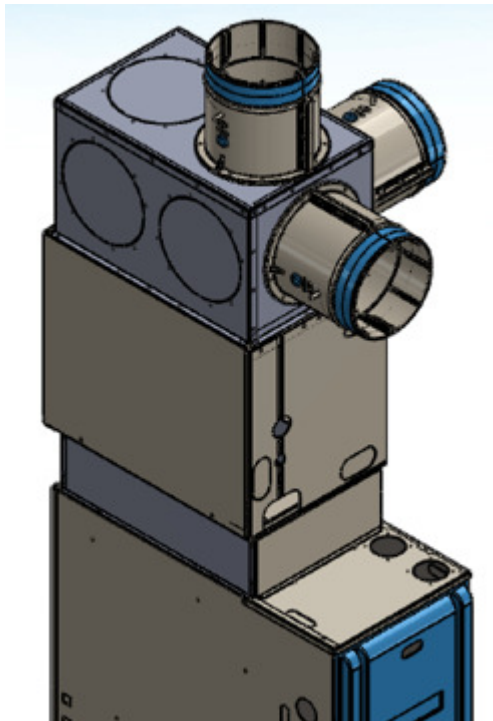

Figure 6: Distribution box

3.6 Trunks

The trunks are the main distribution ducts where the 2.5” branches are connected to supply the entire home with conditioned air. The trunks are round spiral or ‘snaplock’ galvanized steel of 8” or 6” in diameter only of a minimum of 29 Gauge. When ‘snaplock’ type ducts are used, the seam must be sealed. Couplings, elbows, Ys and Ts can be used to direct the trunks where it is required. All couplings shall be carefully sealed. The trunks shall be configured from the distribution box to be able to reach all diffusers in each room within a minimum distance (see section 3.7.2). They can be placed in the joist between floors (or under).

The trunks and the 2.5” branches must be installed in a conditioned space. Installation in crawl space and attic is not be permitted, unless well insulated.

For example, in a standard installation, in a two-story house with a basement, the furnace can be installed in the basement. One trunk is then laid under the ceiling of the basement to supply all necessary diffusers for the basement. Then, another trunk is also laid under the ceiling of the basement to supply all the branches going up to the first floor. Finally, a third trunk connects the distribution box to the ceiling of the first floor to supply all the branches going up to the second floor.

See table below for the design parameters of the trunks.

Trunk diameter	Maximum CFM	Maximum equivalent length
8”	430	150’
6”	250	150’

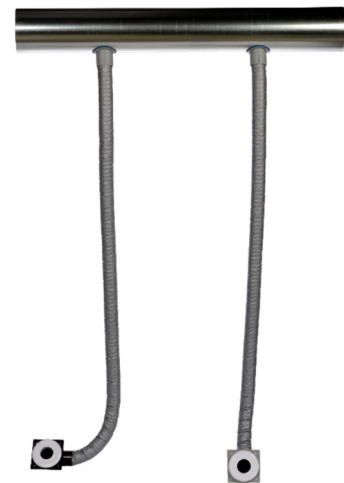

Figure 7: Smart Duct Trunk

3.7 2.5" branches

The 2.5" branches are assembled with 4 components: the saddle that is connected to the trunk; the 2.5" flex duct running into wall and joists; the collar and the diffuser.

3.7.1 The saddles

There are four types of saddles that can be used to connect to the 2 sizes of trunks: the 6" and the 8". Each of those sizes are offered straight or 45 deg angled. The 6" saddle is black and the 8" is grey. Prior to install the saddle on the trunk, a 2.5" hole must be drilled in the trunk at the location indicated by the plans. Once the trunk is drilled, screw a 2.5" flex duct inside the saddle. Pull on the flex to verify that it's well installed on the saddle. The flex should hold tight on the saddle. Screw the saddle on the trunk using self-tapping screws. Do not overtighten the self-tapping screws as they can distort or break the saddle or strip in the trunk. In order to ease the installation, a stub protrudes from the base of the saddle to ensure the proper alignment with the drilled hole in the trunk. A soft gasket is already integrated into the base of the saddle to ensure air tightness with the trunk. No additional sealant is required.

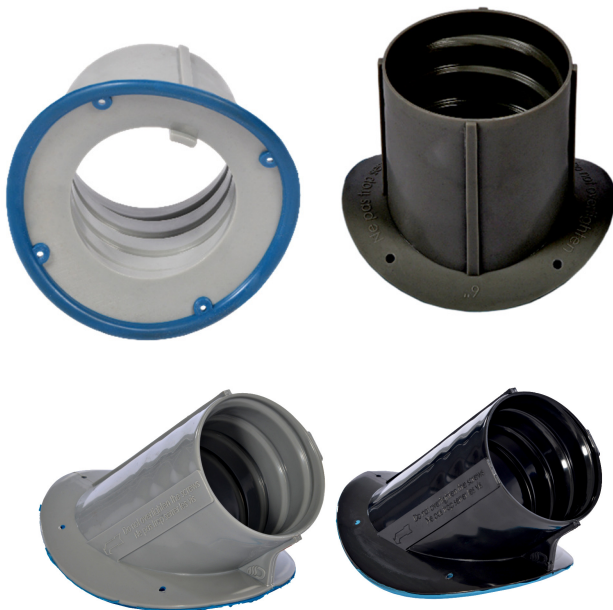

Figure 8: Saddles 8" (grey) and Saddles 6" (black)

3.7.2 The 2.5" flex duct

The 2.5" flex duct is approved as UL-181, Class 1 air ducts. Only the approved duct can be used with this

system. The maximum length of flex is 25'; the flex duct comes in length of 25', 15' and 7' and no joint is permitted. All flex duct runs of 25' or less shall be of one piece. In other words, a 7' flex cannot be joined to a 15' to make a 22'. The flex duct must be fully extended. In order to minimize the noise at the diffuser, the minimum length of flex is 7 feet. It can run in the joists and walls, inside the conditioned envelope of the house. No part of the distribution system shall be exposed to outdoor weather or temperature.

3.7.3 The collars and the diffusers

The flex duct is then screwed inside the collar. Pull on the flex to verify that it's well installed on the collar. The flex should hold tight on the collar. The flex should not be crushed in any way. Also, it should not come at a 90 degree angle directly at the collar. Strapping may be used to ensure the flex is going straight into the collar. See pictures below.



Figure 9: Do not crush the flex duct

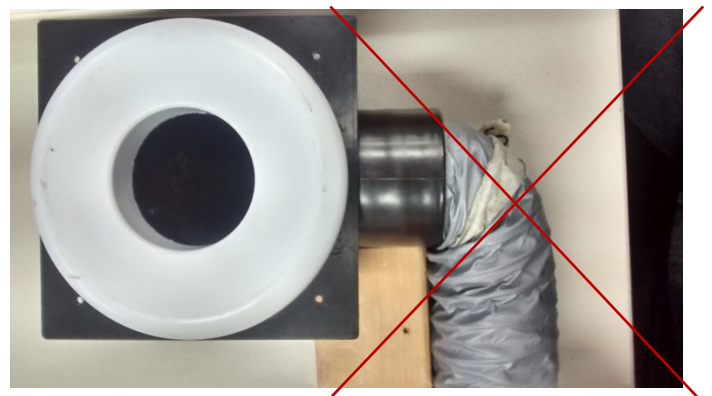

Figure 10: Do not bend the flex duct 90 deg. at the collar

The collars hold the flex securely against a stud under the drywall. During the construction of the wall, screw the construction cap on the opening of the flex to prevent construction debris and dust to get in.



Figure 11: Construction cap

Once the walls are finished and painted, the diffusers can be screwed over the flex duct and the collar.

When positioning a diffuser in a room, it is desirable to minimize the flex duct length (but not less than 7 feet). The diffusers should be placed on walls, at a distance of 6" from the ceiling. In this position, the ceiling will make the throw go farther and thus will provide a better air mixing in the room. The diffuser should be preferably positioned to blow toward a window. Usually, this is also a location where the flex duct length is minimized. Sometimes, it is not possible or practical to do so; then the diffuser can be located on a wall perpendicular to the window with the air sweeping the window. However, it is not necessary to have air sweeping the windows or the exterior walls, especially concerning low load today's homes with better insulation and more efficient windows. The surface temperature of exterior walls and windows are closer to the indoor ambient temperature, thus the occupants do not feel the radiant temperature difference and are still comfortable.

When it is not possible to install the diffusers on a wall, in an unfinished basement for example, they can be positioned in the ceiling downward, preferably above a window. In that case it is suggested to install them 6" from a wall to avoid a draft of air downward, thus preventing any inconvenience to a person standing underneath.

When more than one diffuser is required in a room, one can regroup every pair of diffusers side by side to increase the throw.



Figure 12: 90 deg. Collar - White



Figure 13: 90 deg. Collar - Black



Figure 14: Diffuser

Blocked diffuser:

For a room with a very low load (e.g. bathroom), a plug is to be installed on the diffuser. Concerning the CFM calculations, this outlet will give no airflow. This can be useful when it is mandatory by your building code to have a diffuser in each room.

Blocked diffuser shall be indicated as such in the duct layout drawing.



Figure 15: Blocked Diffuser

3.7.4 The returns

The return air has to be sized as per local building codes and good practices, such as HRAI. The maximum static pressure of the return shall be designed at -0.2" w.c. It is a good design practice to line the return air duct with a sound acoustic insulation for 5' away from the furnace.

Since this system runs at low airflow with long cycles, if not continuously, a return in each room (or bedroom) is not required and thus a central return per floor can be considered to lower the cost without affecting the comfort of the occupants.

Moreover, a low wall return in the basement and a high wall return in the upper floor should be considered. During the summer, this will help remove heat on the upper floor while distributing the basement fresh air to other parts of the home. On the contrary, in the winter it will help remove cold air from the basement and distribute the warm air of the upper floor.

Note: a bypass humidifier shall not be installed on the return, with this system. With this low airflow system, the bypass humidifier will bypass almost all supply airflow leaving little airflow to condition the house.

4 Equipment selection and smart duct design

4.1 Manual design procedure

This section explains how to choose the right equipment to meet both demands of heating and cooling, and how to design the duct branches for each room. The following steps must be followed:

1. Have in hand the room to room loads. (BTU/hr)
2. Choose the smallest furnace for the house heating load.
3. Choose the smallest outdoor cooling unit for the house heating gain.
4. Select the total number of diffusers and calculate the heating and cooling CFM per diffuser.
5. Calculate the number of diffusers required per room.
6. Measure the duct length required for each diffuser and correct the heating and cooling CFM.
7. Add or subtract diffusers if deemed necessary.

1. Choose the right sized equipment

From the tables below, select the smallest furnace that has a higher heating capacity than the heat loss of the house. Do the same for the cooling unit using the heat gain of the home. One (1) ton of cooling is 12,000 BTU/h.

Note that for humid regions, a lower CFM per Ton may be advantageous. On the other hand, in dry regions a higher CFM per Ton may be chosen provided that the maximum CFM can be reached.

Models (gas)	Heating cap.	CFM max	Max htg CFM	Min. heating	Min htg CFM	
CC015-M-V	14445	400	330	5778	85	Chinook Compact 15,000 BTU modulating, 1/3 HP, 95% AFUE, 40 to 100% modulating
C015-M-V	14595	600	360	5838	295	Chinook 15,000 BTU modulating, 1/2 HP, 95% AFUE, 40 to 100% modulating
C015-M-S	14595	859	360	5838	295	Chinook 15,000 BTU modulating, 3/4 HP, 95% AFUE, 40 to 100% modulating
C030-M-V	28860	722	420	11544	300	Chinook 30,000 BTU modulating, 1/2 HP, 95% AFUE, 40 to 100% modulating
C030-M-S	28860	1000	420	11544	300	Chinook 30,000 BTU modulating, 3/4 HP, 95% AFUE, 40 to 100% modulating
C045-M-V	43515	800	730	17406	360	Chinook 45,000 BTU modulating, 1/2 HP, 95% AFUE, 40 to 100% modulating
C045-M-S	43515	1000	780	17406	355	Chinook 45,000 BTU modulating, 3/4 HP, 95% AFUE, 40 to 100% modulating
C060-M-V	58080	1235	1000	23232	430	Chinook 60,000 BTU modulating, 3/4 HP, 95% AFUE, 40 to 100% modulating
C060-M-S	72000	1260	1200	28800	480	Chinook 75,000 BTU modulating, 3/4 HP, 95% AFUE, 40 to 100% modulating
C075-M-V	14445	400	330	5778	85	Chinook Compact 15,000 BTU modulating, 1/3 HP, 95% AFUE, 40 to 100% modulating

Models (electric)	Heating cap.	CFM max	Max htg CFM	
SUP10-M240V12	34120	1000	477	Supreme 10kW modulating, 1/2 HP ECM Motor
SUP15-M240V12	51180	1000	715	Supreme 15kW modulating, 1/2 HP ECM Motor
SUP18-M240V12	61416	1000	858	Supreme 18kW modulating, 1/2 HP ECM Motor
SUP20-M240V12	68240	1000	954	Supreme 20kW modulating, 1/2 HP ECM Motor
SUP20-M240V20	68240	1600	954	Supreme 20kW modulating, 1 HP ECM Motor
SUP23-M240V12	78476	1000	1097	Supreme 23kW modulating, 1/2 HP ECM Motor
SUP23-M240V20	78476	1600	1097	Supreme 23kW modulating, 1 HP ECM Motor
SUP25-M240V12	85300	1000	1192	Supreme 25kW modulating, 1/2 HP ECM Motor
SUP25-M240V20	85300	1600	1192	Supreme 25kW modulating, 1 HP ECM Motor
SUP27-M240V20	92124	1600	1288	Supreme 27kW modulating, 1 HP ECM Motor
SUP30-M240V20	102360	1600	1431	Supreme 30kW modulating, 1 HP ECM Motor

Outdoor Cooling unit Model	Max Cooling capacity (BTU/h)	Max CFM @400CFM/Ton
COND-09-01	9,000	300
COND-12-01	12,000	400
COND-18-01	18,000	600
COND-24-01	24,000	800
COND-30-01	30000	1000
COND-36-01	36000	1200

2. Determine the total number of diffusers

There must be a maximum of 33 CFM per diffuser at the maximum designed CFM of the system. Thereby, the furnace operates in its maximum design pressure condition, which is 1" w.c. at the trunks. Start the design with the minimum number of diffusers and add some if necessary. Always use the maximum designed CFM; thus, the system will work properly if the maximum demand occurs.

Example:

Max designed CFM: **800 CFM** (the max designed CFM in cooling is used because a 2 tons coil is used)

Minimum number of diffusers: $800 \text{ CFM} / 33 \text{ CFM/diffuser} = \mathbf{24 \text{ diffusers}}$

Example (the same example will be used for every step):

Total house heat loss: 26,500 BTU/h

Total house heat gain: 22,500 BTU/h

Right-sized furnace: C030-MV/S (Chinook 30k) (28,590 > 26,500 BTU/h)

Right-sized outdoor unit: COND-24-01 (2 Tons) (24,000 > 22,500 BTU/h)

3. Calculate the number of diffusers needed per room

The heat loss and heat gain should be evaluated for each room. Then the number of diffusers per room can be calculated. The calculation must be done for both heating and cooling.

- Number of diffusers = (room heat load * CFM/BTU (heat)) / 33 CFM/diffuser
- Number of diffusers = (room heat gain * CFM/BTU (cool)) / 33 CFM/diffuser

As a first step, the number of diffusers should enable to meet the demands of both heating and cooling, thus the highest number should be chosen. Round down the number of diffusers per room. Do not round up as you will add diffusers afterward.

Depending on the building code of your region, it may be necessary to put a diffuser in a room even if it requires a

very low amount of CFM, like a bathroom. In this case, you may choose to put a blocked CFM diffuser (see section 3.7.3) and neglect its CFM for the following calculations.

Example:

Bedroom 3

Heat loss: 3,125 BTU/h

Heat gain: 2,300 BTU/h

Number of diffuser (heating): $(3,125 \text{ BTU} * 0.0196 \text{ CFM/BTU}) / 33 \text{ CFM/diffuser} = 1.85$, so **1 diffusers**

Number of diffuser (cooling): $(2,300 \text{ BTU} * 0.0333 \text{ CFM/BTU}) / 33 \text{ CFM/diffuser} = 2.3$, so **2 diffusers**

In this case, 2 diffusers would meet the demands of both heating and cooling. However, depending on the requirement in the other rooms of the home and the comfort priority of each room, more diffusers may be needed.

4. Determine the number of trunks and locate the trunks

The trunks should be positioned so they will be near the diffusers in each room in order for the flex duct to be as minimal as possible and to not exceed 25'. Usually, the trunk is located in the center of the house. Make sure to not exceed the maximum permissible CFM per trunk. Ensure that the equivalent length of each trunk does not exceed 150' (See section 3.6). Practically, it can be useful to choose one trunk per floor.

Note: For a zoned system, it is mandatory to use one trunk per zone.

Example:

Max CFM: **800 CFM** (the max CFM in cooling is used because a 2 tons coil is used)

Minimum number of trunks (8" dia.): $800 \text{ CFM} / 430 \text{ CFM/trunk} = 2 \text{ trunks}$

5. Locate the diffusers in each room, measure the duct length needed for each diffuser and correct the CFM per diffuser

Locate each diffuser on the house layout according to the design parameters discussed in sections 3.7.2 and 3.7.3. With the drawings of the house and the scale, measure the duct length needed for each diffuser from its trunk.

After all the lengths are measured, the CFM for each 2.5" branch should be corrected. Use the factors of the table below for this calculation:

Correction factors according to the duct lengths

Length (feet)	7	15	25
Correction factor	1.12	0.94	0.76
Corrected CFM	37	31	25

For length over 25', see comments in section 3.7.2

Example:

Duct length for all 2 diffusers in Bedroom 3 according to the drawing: **7 feet and 15 feet**

Correction factor from Table 2: **1.12 for 15 feet and 0.94 for 7 feet**

Corrected CFM: $1.12 \times 33 \text{ CFM} = 37 \text{ CFM}$; $0.94 \times 33 \text{ CFM} = 31 \text{ CFM}$

Total CFM for Bedroom 3 = **66 CFM**

6. Add or subtract diffusers if necessary

Now that the corrected CFM per diffuser are known, sum all the CFM and compare to the maximum designed CFM. The sum should be higher than the maximum designed CFM but not exceeding it by 30 CFM.

If it is the case, you are set and the system will not exceed the limit of 1" w.c. static pressure in the trunk.

If the sum of all diffusers is lower than the maximum designed CFM, it means that the system will exceed the maximum static pressure. In such case, add diffuser(s), with corrected CFM, to the room(s) that has the lowest CFM compared to what is required until the sum slightly exceeds the maximum designed CFM.

If the sum of all diffusers is higher than the maximum designed CFM by more than 30 CFM, it means you can subtract one or more diffusers. Choose to subtract a diffuser in the room that has the most CFM compared to what is required. Repeat if necessary. If all rooms have

only one diffuser you may choose to install a reduced diffuser in a low load room. (See section 3.7.3)

For a zoned system, you will have to verify that the total diffusers CFM for each zone is higher than the CFM at low fire of the furnace.

4.2 Dettson’s calculator design procedure

1. Enter the heat loss and the heat gain

The calculator will easily select the proper equipment.

	A	B	C	D	E	F	G	H	I	J
1		Project								
3		heat loss	26500	CFM/ton required	400	ENTER DATA IN PINK CELLS - HIDE UNNECESSARY LINES				
4		heat gain	22500							
6		Furnace	C030-MV-S	Output	28590	CFM heating	560	CFM low heating	285	
7		Cooling	COND-24-01	Output	24000	CFM cooling	800	CFM Low cooling	200	
8		CFM/BTU (Cool):	0.0333			Nom. Calc. CFM	0			
9		CFM/BTU (Heat):	0.0196			Max system CFM	800	CFM Max @Low	285	

2. Enter the heating design and the cooling design for each room

	A	B	C	D	E	F	G
13		1st Floor					
14		Bedroom 3	3125	0	0%	2300	
15							
16							
17							
18							
19		diffusers					
20							
21							

3. Determine the number of trunks and locate the trunks

The trunks should be positioned so they will be near the diffusers in each room in order for the flex duct to be as minimal as possible and not exceed 25’ but also in order to minimize the number of elbows. Make sure not to exceed the maximum permissible CFM per trunk. Ensure that the equivalent length of each trunk does not exceed 150’. See section 3.6. Practically, it can be useful to choose one trunk per floor. Identify each trunk with a number that you will enter the calculator in a next step.

For a zoned system, one trunk per zone must be installed.

Example:

Max CFM: **800 CFM** (the max CFM in cooling is used because a 2 tons coil is used)

Minimum number of trunks (8" dia.): 800 CFM / 430 CFM/trunk = **2 trunks**

Locate the diffusers in each room, measure the duct length required for each diffuser

For each room, find the number of diffusers indicated in the column P (Nb of diffusers) and locate them on the home layout according to the design parameters discussed in sections 3.7.2 and 3.7.3. With the drawings of the home and the scale, measure the duct length required for each diffuser from its trunk and fill the columns K and L.

	A	B	I	J	K	L	M	O	P	Q	R
			CFM Heat design	CFM Cool design	Main trunk	Flex length (')	Nominal calculated CFM	Max design CFM	Proposed nb of diffusers	Real nb of diffusers	Blocked diffuser (y or n)
15											
16		1st Floor									
17		Bedroom 3	61	77				77	2	2	
18					2	7	37				
19					2	15	31				
20											
21											

4. Add or subtract diffusers if necessary

Verify the color of the cell totalizing the Nominal calculated CFM (cell M566).

If it's white, then the CFM given by all diffusers is slightly over the Max system CFM and you are all set.

	A	F	G	H	I	J	K	L	M
9		Max system CFM	800	CFM Max @Low	285		Max CFM/diffuser: 33		
10									
11		Load (BTU)					Air distribution		
12		Cooling design	Cooling real	ratio cooling	CFM Heat design	CFM Cool design	Main trunk	Flex length (')	Nominal calculated CFM
549									
550		2300	24000	1043%					
551									
552		2300	24000	1043%	61	77		171	803

If it is red, then the CFM given by all diffusers is lower than Max system CFM and you will need to add one or more diffusers until the cell gets white. Choose to add diffuser(s) to the room with the lower heating or cooling ratio (columns E and H).

	A	F	G	H	I	J	K	L	M	N
9		Max system CFM	800	CFM Max @Low	285		Max CFM/diffuser: 33			
10										
11		Load (BTU)					Air distribution			
12		Cooling design	Cooling real	ratio cooling	CFM Heat design	CFM Cool design	Main trunk	Flex length (')	Nominal calculated CFM	Max d CFM
548		0	9706	#DIV/0!	0	0		100	309	
549										
550		2300	24000	1043%						
551										
552		2300	24000	1043%	61	77		235	764	

If the sum of all diffusers is lower than the maximum designed CFM, it means that the system will exceed the maximum static pressure. Add diffuser(s), with corrected CFM, to the room(s) that has the less heating and cooling ratio until the sum slightly exceeds the maximum designed CFM. Heating and cooling ratio cells (columns E and H) are colored to easily identify the rooms where those ratios are lower or higher than required.

If the sum of all diffusers is higher than the maximum designed CFM by more than 30 CFM, it means you can subtract one or more diffuser. The cell will turn orange. Choose to subtract a diffuser in the room that has the lowest CFM compared to what is required. Repeat if necessary. If all rooms have only one diffuser, you may choose to install a blocked diffuser in a low load room (lower than 15 CFM required). See section 3.7.3.

	A	F	G	H	I	J	K	L	M
9		Max system CFM	800	CFM Max @Low	285		Max CFM/diffuser:	33	
10									
11		Load (BTU)					Air distribution		
12		Cooling design	Cooling real	ratio cooling	CFM Heat design	CFM Cool design	Main trunk	Flex length (')	Nominal calculated CFM
548		0	8454	#DIV/0!	0	0		120	296
549									
550		2300	24000	1043%					
551									
552		2300	24000	1043%	61	77		310	840

For a zoned system, you will have to verify that the total diffusers CFM for each zone is higher than the CFM at low fire of the furnace. Total calculated CFM per zone turns red, orange or white in the same way than the Total in cell M566 above.

Verify that the maximum CFM per trunk is not exceeded and that the equivalent lengths are below 150'.

	A	B	C	D	E	F	G	H	I
568		Trunk	Diameter	TOTAL CFM	Max CFM/trunk	Length (feet)	Elbow (90°)	Elbow (45°)	Equivalent length
569		1	8	383	430	35	2		50
570		2	8	421	430	71	5		108.5
571		3							0

Cells will turn red if incorrect:

	A	B	C	D	E	F	G	H	I
568		Trunk	Diameter	TOTAL CFM	Max CFM/trunk	Length (feet)	Elbow (90°)	Elbow (45°)	Equivalent length
569		1	8	383	430	35	2		50
570		2	8	421	430	95	6	3	155

5 Installation of the diffuser and saddle with the 2.5 inches flexible duct

A small deviation may be necessary due to worksite uncertainties. However, if a large deviation must be made, such as eliminating a diffuser from a room; rerouting the main plenum or connecting a saddle to a different trunk, contact your system designer before proceeding.

Below are the parts required for the installation:

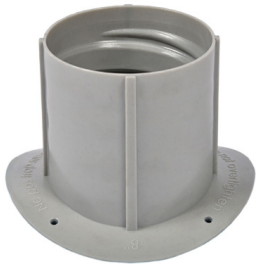

Figure 16: Straight Saddle



Figure 17: 45 deg. Saddle



Figure 18: Diffuser

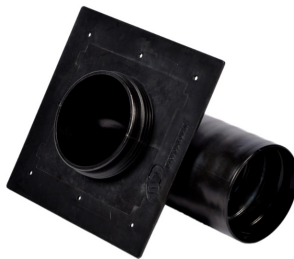

Figure 19: 90 deg. Collar

5.1 Installation of the saddle on the trunk

1. Screw the 2.5" flex duct into the saddle

There is a thread in the saddle; put the spiral of the flex duct in it and turn clockwise until it reaches the base of the saddle. The 2.5" flex duct is approved as UL-181; and only an approved duct can be used with the Right-Sized System®. The maximum length is 25', thus the flex duct comes in length of 25', 15' and 7' and no joint is permitted. In other words, a 7' flex cannot be joined to a 15' to make a 22'. The flex duct must be straight, fully extended and may coiled to reach the diffuser. It can be ran in the joists and walls inside the conditioned envelope of the home. No part of the distribution system shall be exposed to outdoor weather or temperature.



Figure 20: Screw the 2.5" flex into the saddle

2. Screw the saddle on the trunk

There are two types of saddles that can be used to connect to the two (2) sizes of trunks: the 6" and the 8". Prior to install the saddle on the trunk, a 2.5" hole must be drilled in the trunk at the nearest location from the diffuser. Once the trunk is drilled, screw a 2.5" flex duct inside the saddle and screw the saddle on the trunk with self-tapping screws. Do not overtighten the self-tapping screws as they can distort or break the saddle. In order to ease the installation, a stub protrudes from the base of the saddle to ensure the proper alignment with the drilled hole in the trunk. A soft gasket is already imbedded on the base of the saddle to ensure air tightness with the trunk. No additional sealant is required.



Figure 21: Screw the saddle on the trunk

3. Running the flex in the walls and joists

Fully extend the flex duct and run in joists and walls up to the diffuser.

Please do not abuse the 2.5" flex duct as the helix will crush and unravel.

Ensure that it is practicable to drill holes through the joists before proceeding.

CAUTION: Take care when pulling the flex duct through cavities as nails or other objects might puncture it.

5.2 Installation of the diffuser on the wall

1. Screw the 2.5" flex duct into the collar

The collars hold the flex securely against a stud, under the drywall. There is a thread in the collar; put the spiral of the duct in it and turn clockwise.

2. Attach the collar on the wall stud

The collar can be screwed on the wall studs, 6" from the ceiling. Block the diffuser with a construction cap (see Fig. 10) to avoid construction debris and dust to get in. Once the walls are finished and painted, the construction caps can be removed and diffusers can be screwed over the collar.

When positioning a diffuser in a room, the flex duct length should be minimized. The diffusers should be placed on walls, at a distance of 6" from the ceiling. At that position, the ceiling will make the throw go farther and thus it will provide a better air mixing in the room. The diffuser should be preferably positioned to blow toward a window. Usually, this is also a location where the flex duct length is minimized. Sometimes, it is not possible or practical to do so; then the diffuser can be located on a wall perpendicular to the window (again 6" to the ceiling) with the air sweeping the window. When it is not possible to install the diffusers on a wall, in an unfinished basement for example, they can be positioned in the ceiling downward, preferably above a window. In that case, it is suggested to install the diffuser 6" from a wall thus preventing any inconvenience to a standing person under.

Install the construction cap (Figure 11) to avoid debris and dust entering the system.



Figure 22: Attach the collar on the wall stud

3. Install the gypsum

Use a 4" dia. hole saw to do the hole in the gypsum. By using the construction cap, it will make sure there is enough space between the collar and gypsum so the diffuser will screw easily on it.



Figure 23: Install the gypsum & finish the wall

4. Screw the diffuser on the collar

When the wall is all finished, install the diffuser. Screw the diffuser clockwise until it slightly touches the wall.

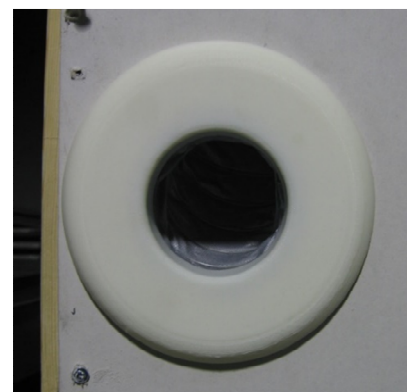

Figure 24: Screw the diffuser on the collar

6 Design parameters summary

Rules for trunks and flex:

- Minimize the length of flex up to 25' max;
- Minimize the number of elbows;
- Respect maximum CFM & length.

Rules for diffusers:

- Design for the shortest possible flex duct length;

- 1st choice location: On the wall facing the window, 6" from the ceiling to the edge of the flex duct, toward the window;
- 2nd choice location: On the wall perpendicular to the window, 6" from the ceiling, sweeping the window;
- 3rd choice location: Down from the ceiling, 6" away from a wall, preferably over a window;
- When more than one diffuser in a room, regroup by pair side by side to increase the throw.

Models (gas)	Heating cap.	CFM max	Max htg CFM	Min. heating	Min htg CFM	
CC015-M-V	14445	400	330	5778	85	Chinook Compact 15,000 BTU modulating, 1/3 HP, 95% AFUE, 40 to 100% modulating
C015-M-V	14595	600	360	5838	295	Chinook 15,000 BTU modulating, 1/2 HP, 95% AFUE, 40 to 100% modulating
C015-M-S	14595	859	360	5838	295	Chinook 15,000 BTU modulating, 3/4 HP, 95% AFUE, 40 to 100% modulating
C030-M-V	28860	722	420	11544	300	Chinook 30,000 BTU modulating, 1/2 HP, 95% AFUE, 40 to 100% modulating
C030-M-S	28860	1000	420	11544	300	Chinook 30,000 BTU modulating, 3/4 HP, 95% AFUE, 40 to 100% modulating
C045-M-V	43515	800	730	17406	360	Chinook 45,000 BTU modulating, 1/2 HP, 95% AFUE, 40 to 100% modulating
C045-M-S	43515	1000	780	17406	355	Chinook 45,000 BTU modulating, 3/4 HP, 95% AFUE, 40 to 100% modulating
C060-M-V	58080	1235	1000	23232	430	Chinook 60,000 BTU modulating, 3/4 HP, 95% AFUE, 40 to 100% modulating
C060-M-S	72000	1260	1200	28800	480	Chinook 75,000 BTU modulating, 3/4 HP, 95% AFUE, 40 to 100% modulating
C075-M-V	14445	400	330	5778	85	Chinook Compact 15,000 BTU modulating, 1/3 HP, 95% AFUE, 40 to 100% modulating

Models (electric)	Heating cap.	CFM max	Max htg CFM	
SUP10-M240V12	34120	1000	477	Supreme 10kW modulating, 1/2 HP ECM Motor
SUP15-M240V12	51180	1000	715	Supreme 15kW modulating, 1/2 HP ECM Motor
SUP18-M240V12	61416	1000	858	Supreme 18kW modulating, 1/2 HP ECM Motor
SUP20-M240V12	68240	1000	954	Supreme 20kW modulating, 1/2 HP ECM Motor
SUP20-M240V20	68240	1600	954	Supreme 20kW modulating, 1 HP ECM Motor
SUP23-M240V12	78476	1000	1097	Supreme 23kW modulating, 1/2 HP ECM Motor
SUP23-M240V20	78476	1600	1097	Supreme 23kW modulating, 1 HP ECM Motor
SUP25-M240V12	85300	1000	1192	Supreme 25kW modulating, 1/2 HP ECM Motor
SUP25-M240V20	85300	1600	1192	Supreme 25kW modulating, 1 HP ECM Motor
SUP27-M240V20	92124	1600	1288	Supreme 27kW modulating, 1 HP ECM Motor
SUP30-M240V20	102360	1600	1431	Supreme 30kW modulating, 1 HP ECM Motor

Outdoor Cooling unit Model	Max Cooling capacity (BTU/h)	Max CFM @400CFM/Ton
COND-09-01	9,000	300
COND-12-01	12,000	400
COND-18-01	18,000	600
COND-24-01	24,000	800
COND-30-01	30000	1000
COND-36-01	36000	1200

Length (feet)	7	15	25
Correction factor	1.12	0.94	0.76
Corrected CFM	37	31	25
	Static Pressure (in. w.c.)		
	@ furnace	@ trunk	@ return
Operation	0.3 @ 0.8	0.2 @ 0.6	-0.1
Max designed CFM	1.4	1	-0.2

Trunk diameter	Max CFM	Maximum equivalent length
8''	430	150'
6''	250	150'
2.5''	33 (*)	25'

7 Inspection checklist

Once the furnace, the trunks and all branches are installed, it is time to do the inspection. Perform the inspection prior to the installation of the dry wall to be able to inspect all the duct system components.

The connections of the trunks to the distribution box, over the furnace and A-coil are well fixed and sealed;

The unused 8" diameter holes on the distribution box are taped;

All trunks connectors are sealed. If "snap lock" ducts are used, all seams are sealed;

The saddles are well screwed in the trunks but are not overtighten to create deformation or cracks;

All diffusers are connected to a trunk (no dead diffusers);

All flex ducts are completely extended;

All flex ducts are of one piece. No joint is allowed;

All flex ducts are 7' long minimum;

No flex duct has been abused or are kinked or restricted in any way;

No sharp elbows of the flex ducts directly at the collars;

The number of diffusers for each room as per drawing;

The diffusers are placed high wall, 6" from the ceiling except when noted on drawing;

Turn the system ON by asking 100% of heat to the thermostat and verify the following points:

Differential static pressure between the furnace supply (before cooling coil) and the return is less than 1.7" w.c.;

All diffusers (except reduced CFM diffusers) give good throw of air;

No noticeable air leak can be detected by placing hands close to the connectors.

When the verification is completed satisfactorily, turn the system off:

Use construction cap on the collars to avoid debris and dust entering the system.