



# Free Match Series R410A GTH Floor and Ceiling Indoor Unit (For North America)

Owner's Manual  

---

Commercial Air Conditioners



Thank you for choosing Commercial Air Conditioners, please read this owner's manual carefully before operation and retain it for future reference.

## User Notice

◆ When installing, the entire capacity of the cooperating indoor unit should be not larger than 150% of outdoor unit, otherwise, it will cause the shortage of cooling (heating) capacity.

◆ The power supply of the entire unit must be the power supply of outdoor unit. And disconnect the main power of outdoor unit before cleaning.

◆ In order to start up the unit successfully, the main power switch should be opened 8 hours before the operation.

◆ After receiving the turn off signal, every indoor unit will continue to work for 20-70sec to make good use of the rest cool air or the rest heat air in the heat exchanger, which will prepare for the next operation. And this is normal.

◆ When the selected operating mode of the indoor unit is conflicted to the operating mode of the outdoor unit, 5 sec later, the malfunction hint will be shown on the indoor unit or wired controller, then the indoor unit will stop. At this time, change the operating mode of the indoor unit to the one that would not conflict with the outdoor operating mode to make the operation normal. The HEAT mode conflicts with each of the COOL mode, DRY mode and FAN mode, while the COOL mode, DRY mode and FAN mode are compatible between each other.

◆ The appliance shall not be installed in the laundry. The appliance shall not be used by children without supervisor.

◆ Power supply fluctuating range (+/-10%, +/-1Hz) .

◆ Humidity range: 30%~95%.

◆ Main switch provided by end user: main switch handle should be black or gray, it can be locked in "OFF" position with padlock.

◆ The main disconnection device should be installed at a height of 0.6~1.7m. Over current protection is required(UL 1995,CSA C22.2).

◆ The cooling range of the unit is the outdoor ambient temp -5~48°C DB, the heating range of the unit (only for the heat pump type unit) is the outdoor ambient temp. -15~27°C DB.

◆ This appliance is not intended for use by persons (including children) with reduced physical, sensory or mental capabilities, or lack of experience and knowledge, unless they have been given supervision or instruction concerning use of the appliance by a person responsible for their safety. Children should be supervised to ensure that they do not play with the appliance.



This product must not be disposed together with the domestic waste. This product has to be disposed at an authorized place for recycling of electrical and electronic appliances.

**Thank you for selecting Gree air conditioner. Before use, please read this manual carefully and keep it properly for further reference.**

# Contents

1 Safety Precautions .....	1
2 Installation Precautions and Location Choosing .....	2
2.1 Installation Precautions .....	2
2.2 Location Choosing .....	2
2.3 Imappropriate Location .....	2
3 Installation of Floor and Ceiling Type Indoor Unit.....	3
3.1 Space Dimension for Unit Installation .....	3
3.2 Important Notice.....	3
3.3 Installation Description.....	3
3.4 Electrical Wiring .....	6
3.5 Drainpipe Installation .....	7
3.6 Install the Connection Pipes .....	8
4 Part Names of Floor and Ceiling Type Indoor Unit.....	10
5 Working Temperature Range.....	11
6 Maintenance Method .....	12
6.1 Cleaning the Air Filters.....	12
6.2 Cleaning the Unit .....	12
6.3 At the Start of the Season .....	12
6.4 During the off Season .....	12
7 Operating Instructions .....	13
8 Malfunction Analysis .....	15
8.1 Service Center .....	15
8.2 After-sales Service .....	16

## 1 Safety Precautions

Please read this manual carefully before using this unit. Operate it correctly according to the guide in this manual.

Please pay special attention to the indicating meaning of these two marks:

**⚠ Warning!** This mark means that the unit may cause property damage, personal injury or loss of life if the operation is incorrect.

**⚠ Caution!** This mark means that the unit may cause minor or moderate property damage or personal injury.

**⚠ Warning!**

◆ The unit should be earthed reliably. Do not connect the earth line to the gas pipe, water pipe, drainage pipe or other unsafe places in potential.

◆ Air conditioner must use special power supply circuit and switches for creepage protect and air with enough capacity should be installed in the circuit.

◆ Ensure that the connecting of power cord is reliable, otherwise, electric shock or fire may happen.

◆ Do not cut off the power supply when the unit is running, otherwise the lifetime of the unit will be shortened.

◆ Do not damage wires or use the wires that are not recommended, otherwise, electric shock or fire may happen.

◆ Please don't operate the unit with wet hands, or electric shock may happen.

◆ Do not put a finger, a rod or other objects into the air outlet or inlet to avoid of damage or injury.

◆ Cut down the main power supply immediately if any abnormality happens (such as smell of fire etc.). Contact with the service center and consult the qualified technician.

◆ Do not repair or adjust the air conditioner by yourself. Please contact the service center or Gree technicians for help.

◆ Do not use the fuse with unsuitable capacity or iron thread instead of fuse, otherwise, it will cause malfunction or fire.

◆ Switch off the power supply of the unit before cleaning the air conditioner, otherwise, electric shock or damage may happen.

◆ Please turn off the main power of the whole unit before cleaning the conditioner, otherwise electric shock or harm may be happened.

◆ Chemical sprayer should be placed 1m or more away from the unit, otherwise fire or explosion may happen.

◆ Do not block air inlets or outlets. Impaired air flow may result in insufficient performance or trouble.

## 2 Installation Precautions and Location Choosing

### 2.1 Installation Precautions

The installation of air conditioner must be conform to national and local safety laws.

Installation quality will directly affect the normal use of air conditioner. Do not attempt to install the air conditioner by yourself. Please contact your dealer after buying this machine. Professional installation workers will provide installation and test services according to installation manual.

Do not connect to power until all installation work is completed.

### 2.2 Location Choosing

- \* Such a place where cool air can be distributed throughout the room.
- \* Such a place where condensate water could be easily drained out.
- \* Such a place that can handle the weight of indoor unit.
- \* Such a place, which is easy for maintenance.
- \* Such a place where is easy to get connected with the outdoor unit.
- \* Such a place where is 1m or more away from other electric appliances such as television, audio device, etc.
- \* Avoid a location where there is heat source, high humidity or inflammable gas.
- \* Do not use the unit in the moist surroundings, such as a laundry, a bath, a shower or a swimming pool.
- \* Be sure that the installation conforms to the installation drawings.

### 2.3 Inappropriate Location

- \* Where there is too much of oil.
- \* Where it is acid base area.
- \* Where there is irregular electrical supply.

### 3 Installation of Floor and Ceiling Type Indoor Unit

#### 3.1 Space Dimension for Unit Installation

The space around the unit is adequate for ventilation. (Refer to Fig.1)

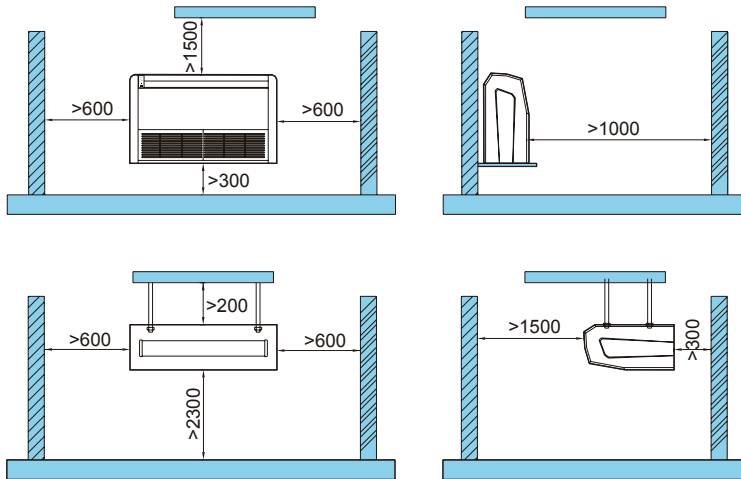

Fig.1

#### 3.2 Important Notice

- (1). The unit must be installed by the professional personnel according to this install instruction to ensure the well use.

Please contact the local Gree special nominated repair department before installation. Any malfunction caused by the unit that is installed by the department that is not special nominated by Gree would not deal with on time by the inconvenience of the business contact.

- (2). It should be done by professional personnel when the air conditioner unit is moved to other place.

#### 3.3 Installation Description

##### \* Ceiling type

##### \* Floor type

These two types of units have similar installing procedure as follows:

- (1). Determine the mounting position on ceiling or wall by using paper pattern to indicate indoor frame. Mark the pattern and pull out the paper pattern.(Refer to Fig.2)
- (2). Remove the return grill, the side panel and the hanger bracket from the indoor unit as per procedure below.

\* Press the fixing knob of the air intake grills, the grilles will be opened wider and then pull them out from the indoor.

\* Loosen the side panel fixing screw and remove the side panel. (Refer to Fig.3)

\* Loosen two hanger bracket setting bolts (M8) on each side for less than 10mm. Remove two hanger bracket fixing bolts (M6) on the rear side. Detach the hanger bracket by pulling it backward

(Refer to Fig.5).

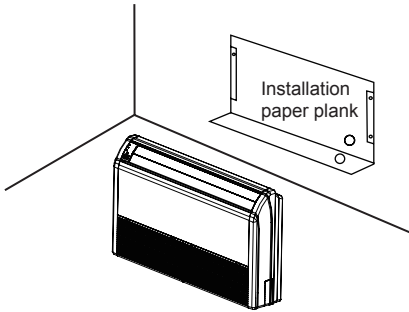

Fig.2

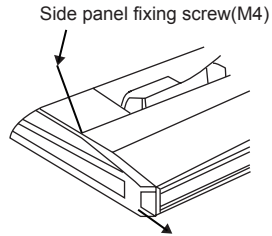

Fig.3

(3). Set the suspension bolt. (Use W3/8 or M10 size suspension bolts)

\* Adjust the distance from the unit to the ceiling slab beforehand. (Refer to Fig.4)

(4). Fix the hanger bracket to the suspension bolt.

**⚠ Warning!**

\* Make sure that extended suspension bolt from the ceiling stays inside the appointed position. Readjust the hanger bracket when it is out of the appointed position. (Refer to Fig.6)

\* Suspension bolt is fixed in the cap of indoor unit. Never remove the cap.

(5). Lift the unit and slide forward unit in place. (Refer to Fig.7)

(6). Screw tightly both hanger bracket-setting bolts (M8). (Refer to Fig.5)

(7). Screw tightly both hanger bracket-fixing bolts (M6) to prevent the displacement of the indoor unit. (Refer to Fig.5)

(8). Adjust the height so that rear side of the drainpipe slightly inclines to improve drainage.

**⚠ Caution!**

\* Adjust the height by rotating the nut with a spanner.

\* Insert the spanner into the hanger bracket through the interspace. (Refer to Fig.8)

In case of hanging

It is possible to install hanger brackets by not removing the brackets from the indoor unit. (Refer to Fig.9)

Only the specified accessories and parts for installation work could be used.

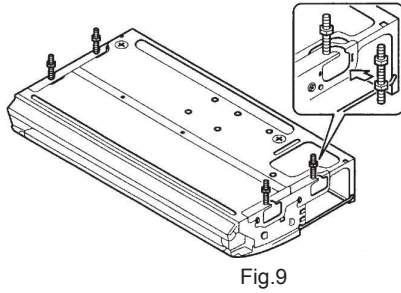
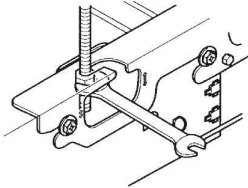
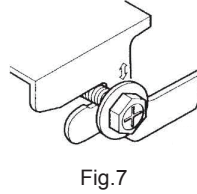
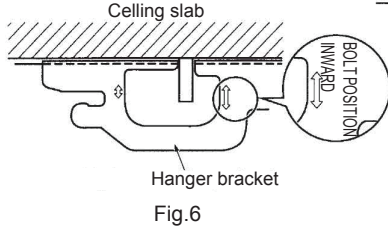
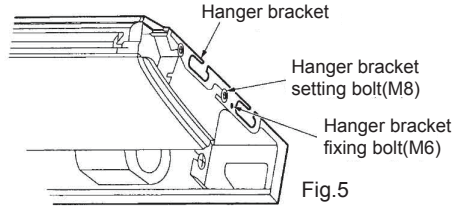
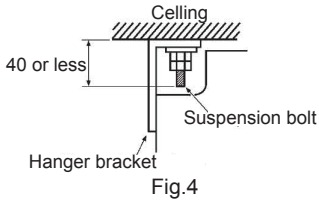

When installing the indoor unit, you can refer the paper pattern for installation. Make sure that the drainage side must be 10mm lower than the other side in order to drain the condensate water easily.

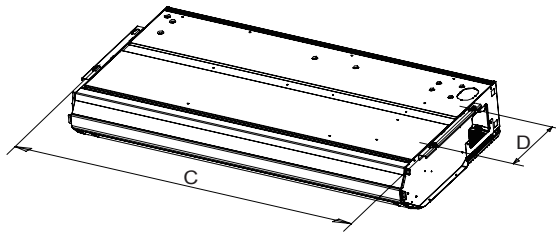

Unit:mm



Model	A	B	H	C	D
GTH(09)BA-D3DNA1A/I	1220	225	700	1158	280
GTH(12)BA-D3DNA1A/I					
GTH(18)BA-D3DNA1A/I					
GTH(24)BA-D3DNA1A/I					

### 3.4 Electrical Wiring



**Caution:**

**The power of every indoor unit should be connected in outdoor unit.**

- ① . Open front panel.
- ② . Remove the electrical box cover.
- ③ . Route the power connection cord from the back of the indoor unit and pull it toward the front through the wiring hole upward.
- ④ . Put the 4-core cable through the hole of the chassis and the bottom of the appliance upward, and then connect the power line and the communication line from the outdoor unit to the corresponding terminals N(1), 2, 3 , and grounding terminal of the indoor unit. Wiring shall be done properly as per the wiring diagram. (Note: Be sure the wiring terminals A/B/C/D and piping joints A/B/C/D of the indoor unit match with that of the outdoor unit respectively).
- ⑤ . Reassemble the electrical box cover.
- ⑥ . Reinstall the front panel.
- ⑦ . Do not use copper tube at interconnection part as the temperature of refrigerant circuit is high.

GWHD(36)ND3AO

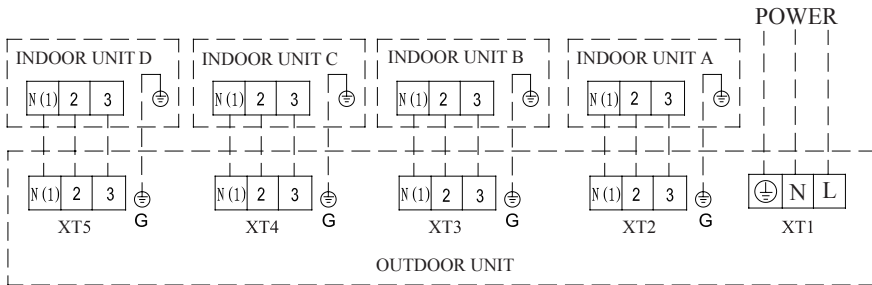

GWHD(42)ND3AO

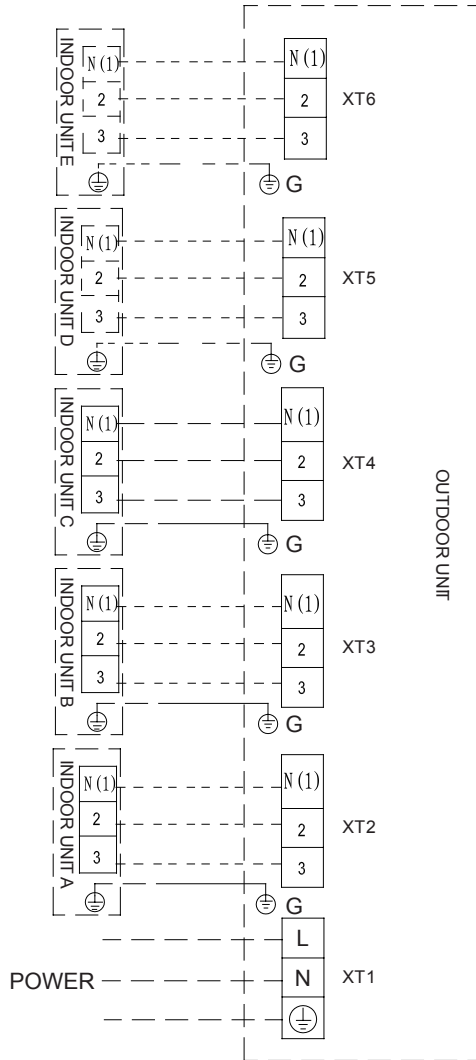

**⚠ Caution!**

- ① . The incorrect of wiring connection would lead malfunction of some of the electric parts.
- ② . Be sure to leave some space between the connecting end and the clamp end after the wiring is fixed.
- ③ . The installing operation should conform to national wiring regulations.

**3.5 Drainpipe Installation**

**Make sure the drain flows out**

- (1). Drain piping.

- \* Either the right rear or right side of the unit is suitable for fixing the drainpipe.
  - \* The diameter of the drainpipe should be equal to or greater than that of the connecting pipe.
  - \* Take the drainpipe as short as possible and slope downward at a gradient of at least 1/100 to prevent air pockets.(Refer to Fig.10)
  - \* Use the attached drain hose ④ and clamp ⑤ .
  - \* Insert the drain hose completely into the drain socket. Tighten the clamp within the range of gray tape until the screw head is less than 4mm from the hose. (Refer to Fig.11, Fig.12)
  - \* Wrap the attached sealing pad ⑪ over the clamp and drain hose to insulate. (Refer to Fig.12)
  - \* No folding of drain hose inside the indoor unit. (Refer to Fig.13)
- (2). Confirm that smooth drainage is achieved after the piping work.

Pour 600cc of water into the drain pan from the air outlet for confirming drainage.(Refer to Fig.14)

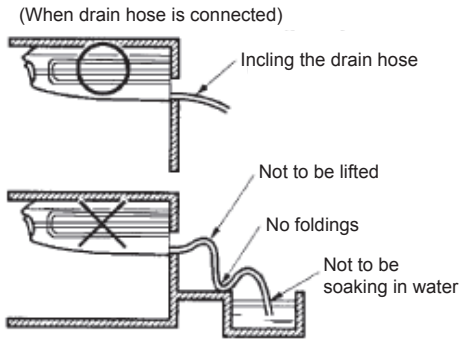

Fig.10

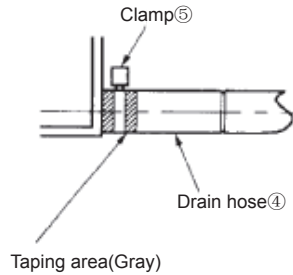

Fig.11

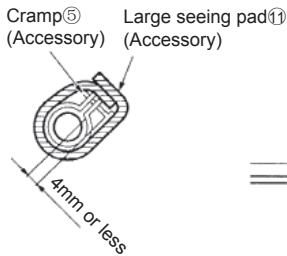

Fig.12



Fig.13

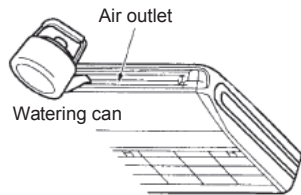
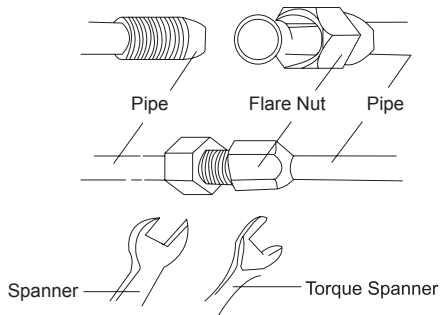

Fig.14

### 3.6 Install the Connection Pipes



Nut-Required Torque

Pipe Diameter	Required Torque
1/4"	15--30
3/8"	35-40
1/2"	45-50
5/8"	60-65

- (1). Align the flared end of the copper tube with the threaded connector, and then hand-tighten the flared nut.
- (2). Further tighten the flared nut with a torque wrench until the torque wrench sounds a "crack".
- (3). The bending of the pipe shall not be too small, otherwise the pipe may crack. A pipe bender must be used when bending the pipe.
- (4). Wrap the thermally untreated pipe and connectors with sponge and then tighten the sponge with plastic tape.

**Notes:**

- ① . During the piping, do not pull any connector forcefully to prevent the capillary and other pipes from cracking, which then would result in leakage.
- ② . The pipe should be properly supported in the way that its weight will not be borne by the unit.

If the specification of the outdoor unit pipe joint does not conform to that of the indoor unit, then the joint specification of the outlet pipe of the indoor unit takes precedence. A reducing nipple shall be installed at the joint of the outdoor unit so as to make the joint of the outdoor unit compatible with that of the indoor unit.

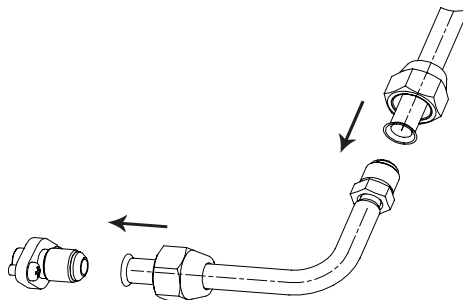

## 4 Part Names of Floor and Ceiling Type Indoor Unit

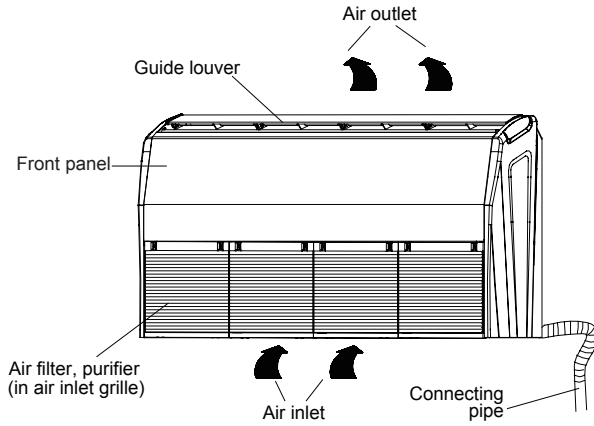

Suitable model:

GTH(09)BA-D3DNA1A/I

GTH(12)BA-D3DNA1A/I

GTH(18)BA-D3DNA1A/I

GTH(24)BA-D3DNA1A/I

**Note:** Different models of air conditioners as shown above have the same appearances.

## 5 Working Temperature Range

Working Temperature Range

	Indoor side state °F (°C)		Outdoor side state °F (°C)	
	Dry bulb temp. °F (°C)	Wet bulb temp. °F (°C)	Dry bulb temp. °F (°C)	Wet bulb temp. °F (°C)
Rated. Cooling	80.0(26.7)	67.0(19.4)	95.0(35.0)	75.0(23.9)
Max. cooling	80.0(26.7)	67.0(19.4)	115.0(46.1)	75.0(23.9)
Min. cooling	67.0(19.4)	57.0(13.9)	67.0(19.4)	57.0(13.9)
Rated. Heating	70.0(21.1)	60.0(15.6)	47.0(8.3)	43.0(6.1)
Max. heating	80.0(26.7)	—	75.0(23.9)	65.0(18.3)
Low Ambient heating	70.0(21.1)	60.0(15.6)	5.0(-15.0)	3.2(-16.0)

## 6 Maintenance Method

### **⚠ Warning!**

① . Turn off the unit and cut off the power supply when cleaning the air conditioner, otherwise, electric shock may happen.

② . Do not let the air conditioner get wet, or it will cause electric shock. Ensure that the air conditioner will not be cleaned by water rinse under any circumstances.

③ . Volatile liquid like thinner or gasoline would damage the appearance of air conditioner. (Note: Only soft cloth and wet cloth that moistened by neutral cleaning fluid could be used to clean the front panel of air conditioner.)

### 6.1 Cleaning the Air Filters

#### **⚠ Warning!**

**Air filters should be cleaned by professionals with proper operation to ensure personal safety.**

#### **Suggestion:**

If the air filter is dirty, it will influence normal airflow. As a result, the unit will be overloaded and consume 6% additional electric energy. So regular cleaning is necessary.

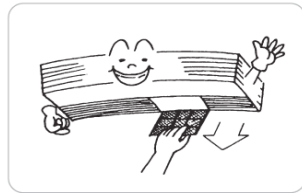

### 6.2 Cleaning the Unit

Clean the air conditioner and the remote control with dry cloth or a vacuum cleaner. If damp cloth is used, remove moisture by using dry cloth afterward.

#### **⚠ Caution !**

① . Do not use benzene solvent, gasoline, thinners or polishing products for cleaning.

② . Do not wash with hot water (above 40 °C ). Some parts of the unit may be deformed.

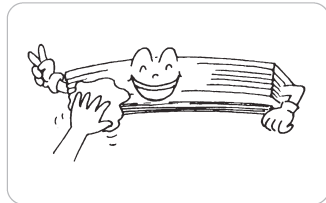

### 6.3 At the Start of the Season

- \* Check if there is blockage at inlet and outlet of the air conditioner.
- \* Check if the batteries in wireless remote controller has been exchanged.
- \* Check if the batteries in wireless remote controller had been exchanged.
- \* Check if the air filter has been installed well by professionals.
- \* In order to start up the air conditioner smoothly after long period stop, switch on the main power supply 8 hours before turning on the air conditioner.
- \* Notice: All the operations above should be operated by professionals.

### 6.4 During the off Season

- \* Switch off the main power supply.
- \* Clean the air filters and other parts by professionals.
- \* Keep the fan running for 2-3 hours to dry out the inside of the unit.
- \* Notice: All the operations above should be operated by professionals.

## 7 Operating Instructions

\* The expected temperature should be set at a moderate level to avoid of unnecessary energy consumption.

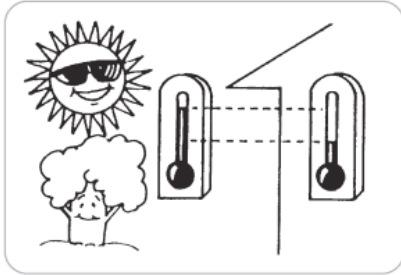

\* Airflow direction will be changed by adjusting the louvers and flaps as shown, accordingly well air condition the room temperature.

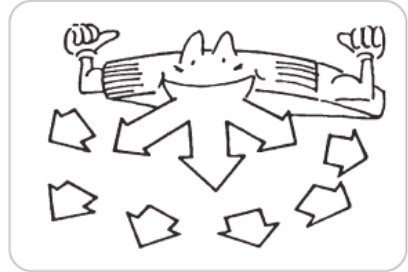

\* Clean the air filter every week for higher efficiency by professional.

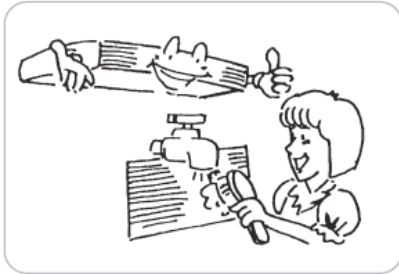

\* Close the window and door while operating the unit for saving energy.

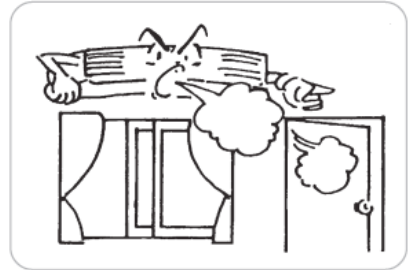

\* Cover windows with a blind or a curtain to prevent heat source from sunlight when the unit is cooling, which helps to reduce energy consumption.



\* In case of ineffective ventilation, open the window to ventilate room air occasionally, meanwhile, close the window timely for saving energy.

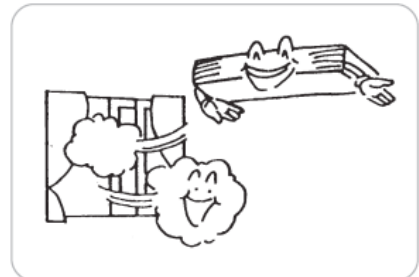



\* Check electrical system (voltage and frequency). Use the power supply indicated on the nameplate of the unit to operate the air conditioner and only fuses with specified capacity should be done by technicians. Do not use pieces of wire instead of fuse.



\* If electric shock suddenly happens, turn off the unit. If the unit is not to be used for a long period, cut off the main power supply.



\* Do not insert objects into the air inlet or outlet when the air conditioner is running as it may cause damage or personal injury. Also pay special attention when children are around.

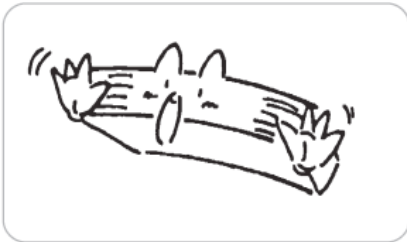

\* Do not place any obstacles around the indoor and outdoor unit to avoid of inefficient performance or malfunction.

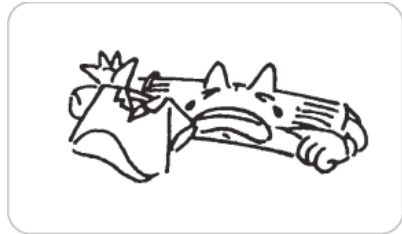

\* Never expose infants, aged persons or patients directly to the air flow.



\* Do not locate a heater or any other heat source close to the unit. The heat may deform plastic parts.



## 8 Malfunction Analysis

### Warning!

**Repairing work should be done by Gree technicians. For saving your time and spending, please check the following malfunction analysis before contacting customer service center.**

Malfunction Phenomena	Malfunction Analysis
After turning off the air conditioner, the unit could not restart immediately.	The overload protection switch of the unit needs 3 mins before restarting.
Odor gives out when the unit just turns on.	When air conditioning, odor or smoke that was sucked in is discharged again.
Slight noise is heard when the unit is running.	The refrigerant flows in the liquid pipe will make some noise.
There is mist coming from air outlet under cooling mode.	Indoor temperature declines too fast.
Creak sound is heard when the unit is running or shut down.	When the ambient temperature changes, the panel and other parts expand or shrink, which might cause some grating sound.
The air conditioner could not run.	Whether the unit is powered off. Whether the unit is disconnected with power supply. Whether the circuit breaker trips off. Whether the voltage is too high or too low. Whether the TIMER has been set in the wireless remote controller. Notice: All the operations above should be done by Gree technicians.
The cooling (heating) effect of the air conditioner is not good.	Whether the temperature is set properly. Whether the inlet or outlet of the unit is blocked. Whether the air filter is too dirty to cause blockage. Whether the windows and doors are closed. Whether the airflow volume is set at low speed. Whether there is any heat source in the room.
Wireless remote controller doesn't work.	If the wireless remote controller doesn't work with new batteries, remove the back cover and press "ACL" button to make it normal. The air conditioner is under abnormal disturbance or changing function too frequently, to make wireless remote controller cannot control. Cut off main power supply and re-electrify could resume normal operation. Whether the controller is within the signal receiving area; Whether there is blockage; Check if the batteries in wireless remote controller are worn out, otherwise change the batteries.

### Note:

When the wired controller is connected, the indoor unit display is invalid and the unit won't receive the remote control command. The phenomena is natural.

### 8.1 Service Center

When the following phenomena appears, please stop operating immediately, cut off the power supply and contact service center for help.

- \* Harsh sound is heard when the unit is running.
- \* When the fuse melts or the circuit breaker trips off frequently.
- \* When some objects or water is sucked in the unit accidentally.

- \* When there is water leakage from indoor unit.
- \* When the power cord is overheating.
- \* Odor gives out when the unit is running.

## 8.2 After-sales Service

Please contact the dealer if the air conditioner has any quality problems.

